



SITGroup

PROFLAME GT-GTM-GTMF-GTMFS



.....

ADVANCED REMOTE CONTROL SYSTEMS



- The Standalone Proflame is an automatic ignition gas control system that includes an user selectable intermittent or standing pilot.

Features include: twin safety system with true flame detection for enhanced safety and reliability, On/Off, Manual Hi/Low, and Remote modulation valve configurations, integrated for use with the Proflame Remote Control GT, GTM, GTMF, GTMS and GTMFS families, operable from a wall switch or a remote control, a low power consumption design provides a choice for AC power, Battery power or AC power with Battery back up.

The 880 Proflame Control provides basic ON/OFF operation of gas flow to the pilot and main burners of the heating appliance.

The 886 Proflame Control has the same functions as the 880 control except that it includes HI/LO knob for manual flame height adjustment.

The Proflame controls are designed to be used with either LPG or Natural Gas and can be converted by use of an OEM supplied conversion kit.

The 880 valves can also be upgraded to 886 configurations by installing OEM supplied conversion kits.

- The Proflame GTMS is a modular remote control system that directs multiple functions of modern hearth appliances. The GTMS is configured to control the on/off and flame height operation of the main burner, provides for thermostatic control of the appliance and Split Flow dual burner control. The control features an advanced Smart thermostat which automatically modulates the flame height optimizing room temperature management.

The Proflame GTMS system is specifically developed to be used together with the Proflame 885 valve, Digital Fireplace Control (DFC) board and provides battery back up in the event of line power loss.

- The Proflame GTMFS is a modular remote control system that directs multiple functions of modern hearth appliances. The GTMFS is configured to control the on/off and flame height operation of the main burner and provides for thermostatic control of the appliance. Additional features include; fan speed control through 6 levels, a remotely actuated 120/60Hz power outlet and Split Flow dual burner control. Comfort control is advanced by the Smart thermostat feature which automatically modulates the flame height optimizing the temperature management and the room ambience.

The Proflame GTMFS system is specifically developed to be used together with the Proflame 885 valve, Digital Fireplace Control (DFC) board and provides battery back up in the event of line power loss.

PROFLAME Standalone

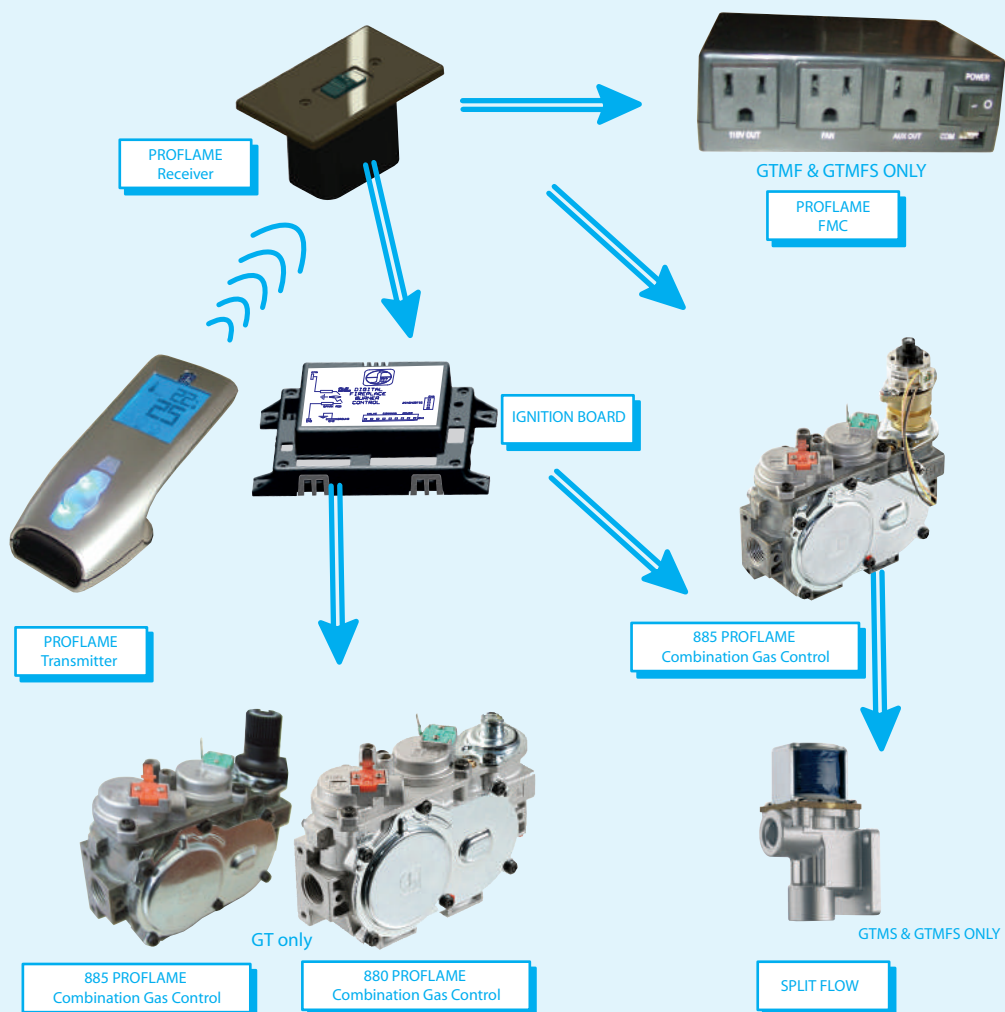
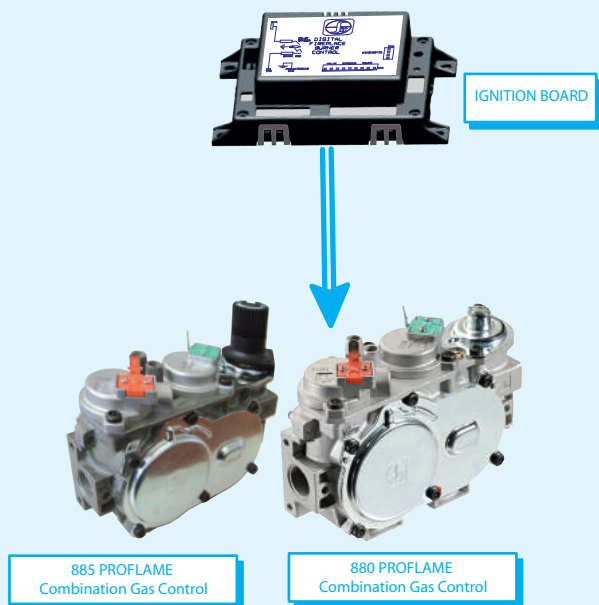



MAIN CHARACTERISTICS

Feature	Icon	PROFLAME				
		GT	GTM	GTMS	GTMF	GTMFS
Room Temperature Display		•	•	•	•	•
Child Lock		•	•	•	•	•
Low Battery		•	•	•	•	•
On/Off Thermostat		•	•	•	•	•
Flame On/Off only		•				
Flame On/Off & Modulation (6 Levels)			•	•	•	•
Smart Thermostat		•	•	•	•	•
Fan Speed Control (6 Levels)					•	•
On/Off Auxiliary Outlet (120V)					•	•
Constant Outlet (120V)					•	•
Split flow				•		•

(•) Indicates included Features

TECHNICAL DATA

REMOTE CONTROL

Supply voltage: 4.5 V (three 1.5 V AAA batteries)
 Ambient temperature ratings: 0 to 50 °C (32 to 122 °F)
 Radio frequency: 315 MHz

RECEIVER

Supply voltage: 6.0 V (four 1.5 V AA batteries)
 Ambient temperature ratings: 0 to 60 °C (32 to 140 °F)
 Radio frequency: 315 MHz



FAN CONTROL MODULE (PROFLAME GTMF & GTMFS only)

Supply voltage/frequency:	120 V / 60 Hz
Ambient temperature ratings:	0 to 60 °C (32 to 140 °F)
Three wires bus:	two wires to provide DC voltage to the receiver; one wire gives uni-directionally signal from the receiver
Output voltage/frequency/current:	120 V / 60 Hz / 5 A
Aux switched output:	120 V / 60 Hz / 2 A
Fan speed output:	120 V / 60 Hz / 1 A

DFC CONTROL BOARD

Supply voltage	DC IN: 7Vdc - 200mA max (Class 2 power supply) BB IN: 6Vdc - 200mA max (four 1.5V size AA batteries)
Ambient temperature ratings	-18 to +80 °C (0 to +176 °F)
Spark voltage	>15kV
Spark energy	>0,7mJ
Spark frequency	1Hz
Tested gas types	the system has been tested both for NG, and LPG gas types/mixtures
Pilot ignition source	Intermittent/Continuous

SYSTEM COMPONENTS

The Standalone System consists of four main elements:

1. Proflame Digital Fireplace Control (DFC)
2. Proflame 880, or 886 families of gas valves
3. Pilot assembly
4. Proflame DFC wiring harness to connect the DFC to the gas valve, and to the pilot burner

The GTMS System consists of eight main elements:

1. Proflame GT Series Transmitter
2. Proflame GT Series Receiver
3. Proflame Digital Fireplace Control (DFC)
4. Proflame Gas Valve 885 family (also the 880, 886 families are compatible)
5. Pilot assembly
6. Split Flow Control (optional)
7. Proflame GT Series wiring harness to connect the Receiver to the DFC wirings, to the Gas valve stepper motor, and to the Split Flow Control
8. Proflame DFC wiring harness to connect the DFC to the gas valve, and to the pilot burner

The GTMFS System consists of nine elements:

1. Proflame GT Series Transmitter
2. Proflame GT Series Receiver
3. Proflame Fan Control Module (FCM)
4. Proflame Digital Fireplace Control (DFC)
5. Proflame Gas Valve 885 family (also the 880, 886 families are compatible)
6. Pilot assembly
7. Split Flow Control (optional)
8. Proflame GT Series wiring harness to connect the Receiver to the FCM, to the DFC wirings, to the Gas valve stepper motor, and to the Split Flow Control
9. Proflame DFC wiring harness to connect the DFC to the gas valve, and to the pilot burner.



TRANSMITTER (Remote Control with LCD Display)

The Proflame Transmitter uses a streamline design with a simple button layout and informative LCD display with blue back light (Fig.1). The transmitter is powered by 3 AAA type batteries. A Mode key is provided to index between the features and a Thermostat key is used to turn on/off or index through thermostat functions (Fig. 1 & 2A & 2B & 2C & 2D).

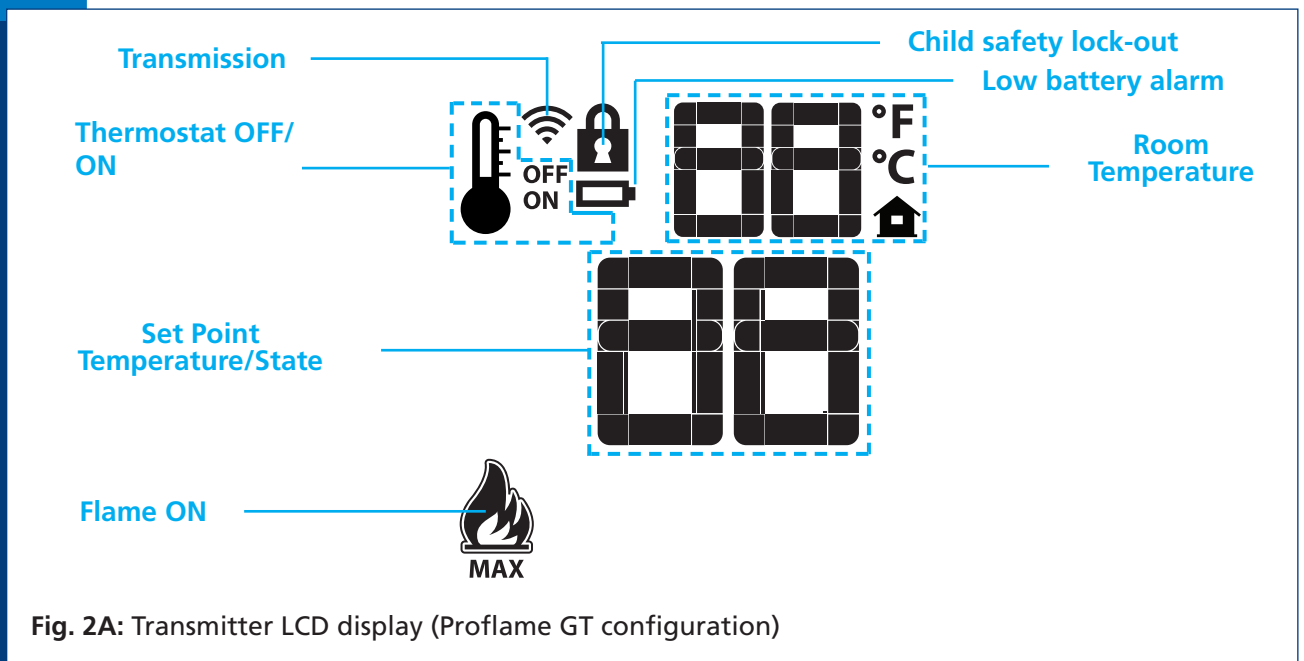
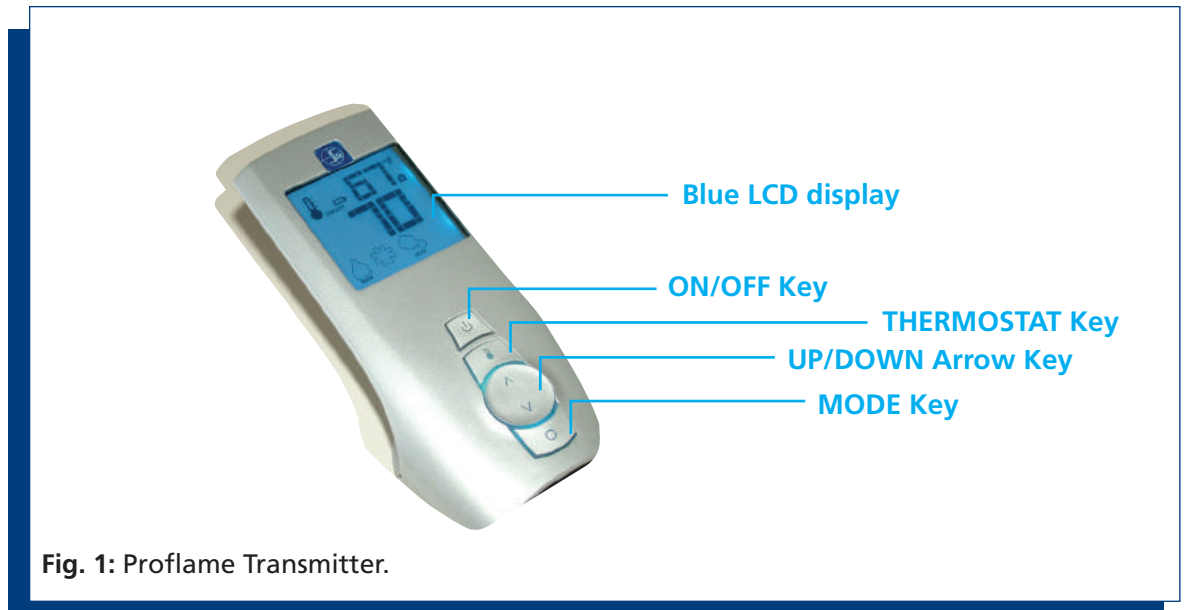

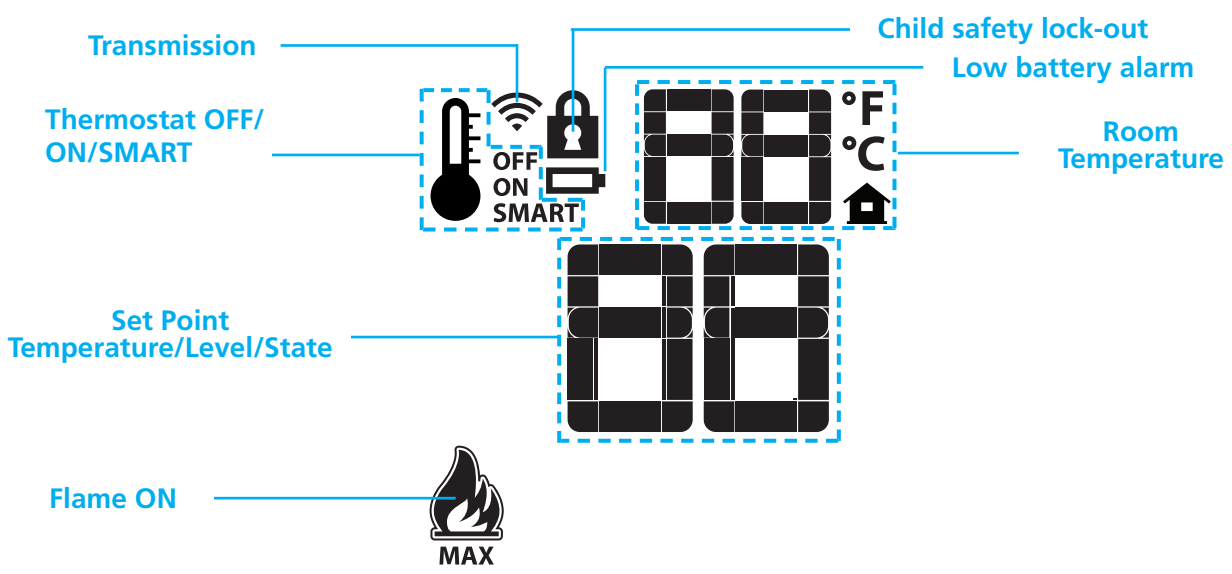

Fig. 2B: Transmitter LCD display (Proflame GTM configuration)

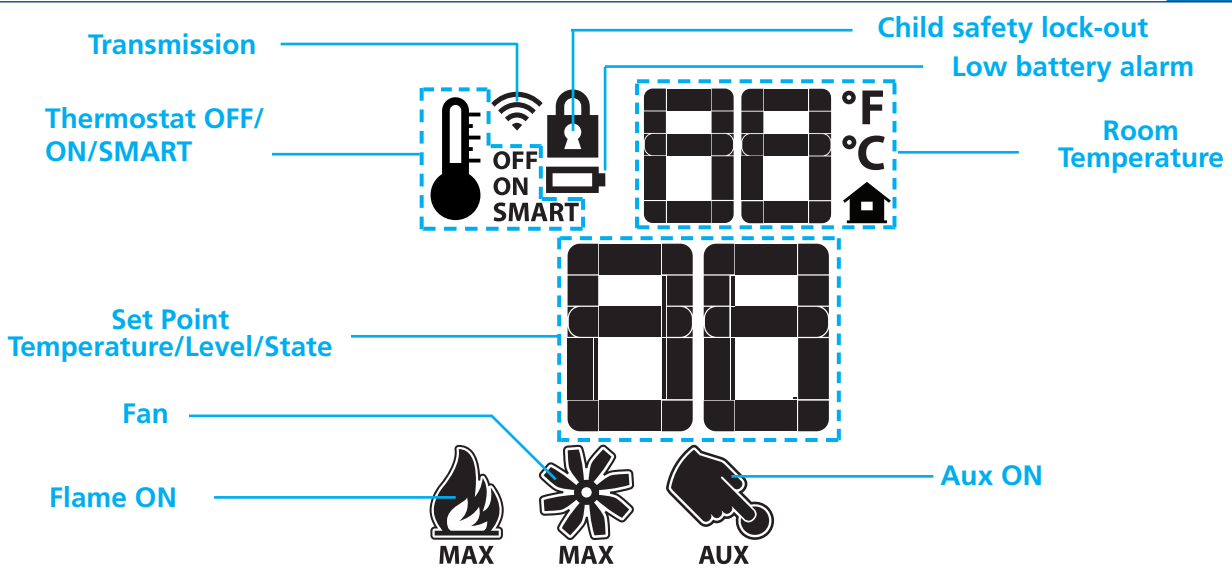

Fig. 2C: Transmitter LCD display (Proflame GTMF configuration)

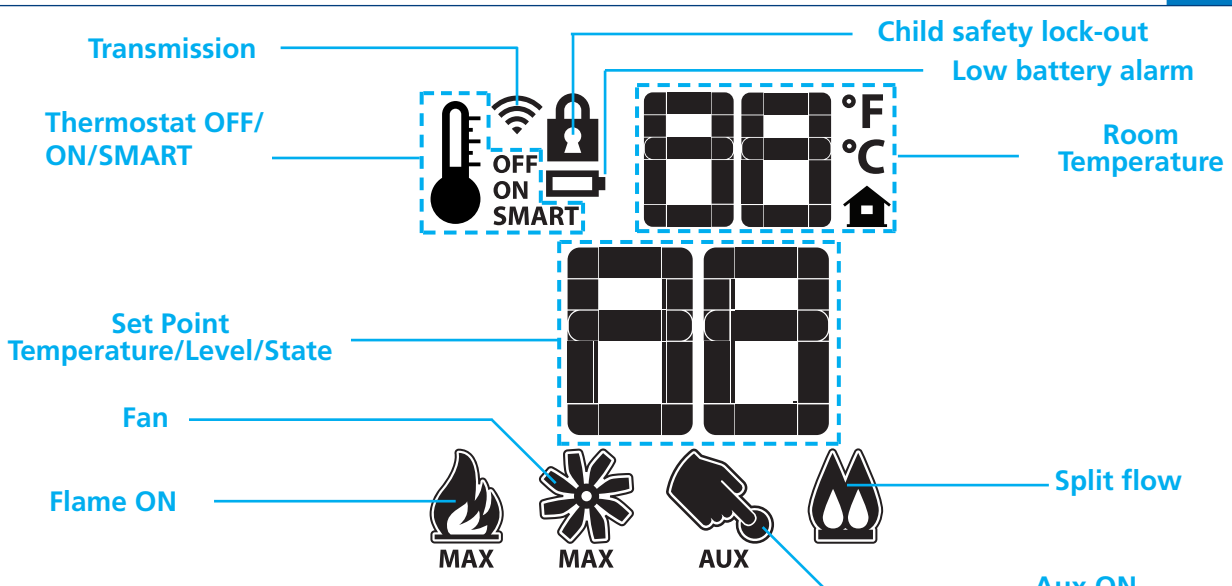

Fig. 2D: Transmitter LCD display (Proflame GTMFS configuration)

RECEIVER

The Proflame Receiver (Fig. 3) connects directly to the gas valve stepper motor, and to the Fan Control Module with a wiring harness. The receiver is powered by 4 AA type batteries. The receiver accepts commands via radio frequency from the Transmitter to operate the appliance in accordance with the particular Proflame system configuration. The Receiver slider switch can be set to one of these three positions: ON (Manual Override), Remote (Remote control) or OFF.

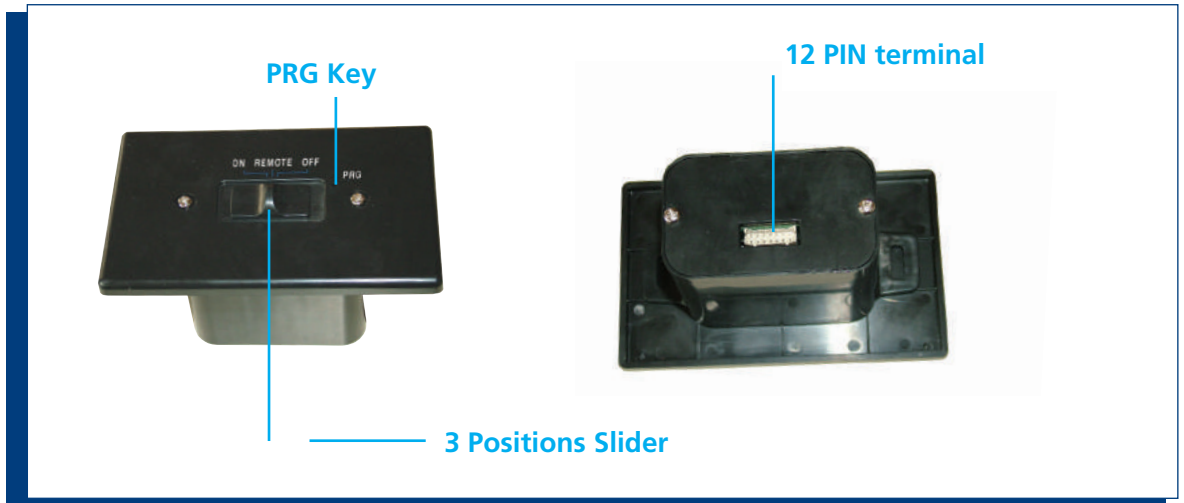

Fig. 3: Proflame Receiver body.

FAN CONTROL MODULE (PROFLAME GTMF & GTMFS only)

Fan Control Module (FCM) offers the added ability to control the fan speed from off through six (6) speeds, a remotely actuated 120V outlet, and a constantly powered 120V outlet. The FCM provides DC power to the receiver allowing the batteries to be used only in the event of line power loss (Fig.4).

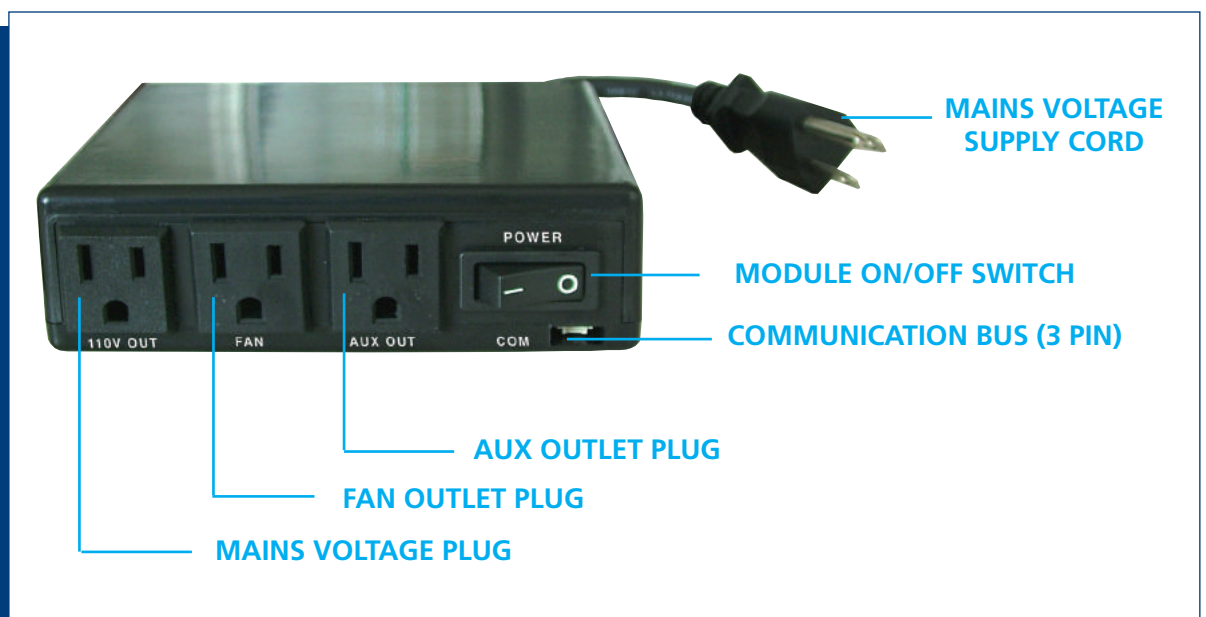

Fig. 4: Fan Control Module.

DFC CONTROL BOARD

The Proflame Digital Fireplace Control (DFC) board is a device that allows the automatic ignition and pilot flame supervision, to command the functions of a hearth appliance, see fig.4A.

It's configured to control the ON/OFF main burner operation, giving the choice of both IPI (intermittent pilot ignition), and CPI (continuous pilot ignition) modes.

The Proflame DFC board controls and connects directly to the pilot assembly and an automatic valve of the Proflame 880, 886 and 885 families using low electric power.

The DFC Board can be powered by an AC/DC wall adaptor and battery pack for back up (Stand Alone System). When used with the Proflame Remote System, with or without a split flow valve, the DFC Board can be powered by an AC/DC wall adaptor via specific wire harness using the receiver batteries for back up (GTM System). Additionally, the DFC Board can be powered by the Fan Control Module (FCM) via specific wire harness using the receiver batteries for back up (GTMF System).

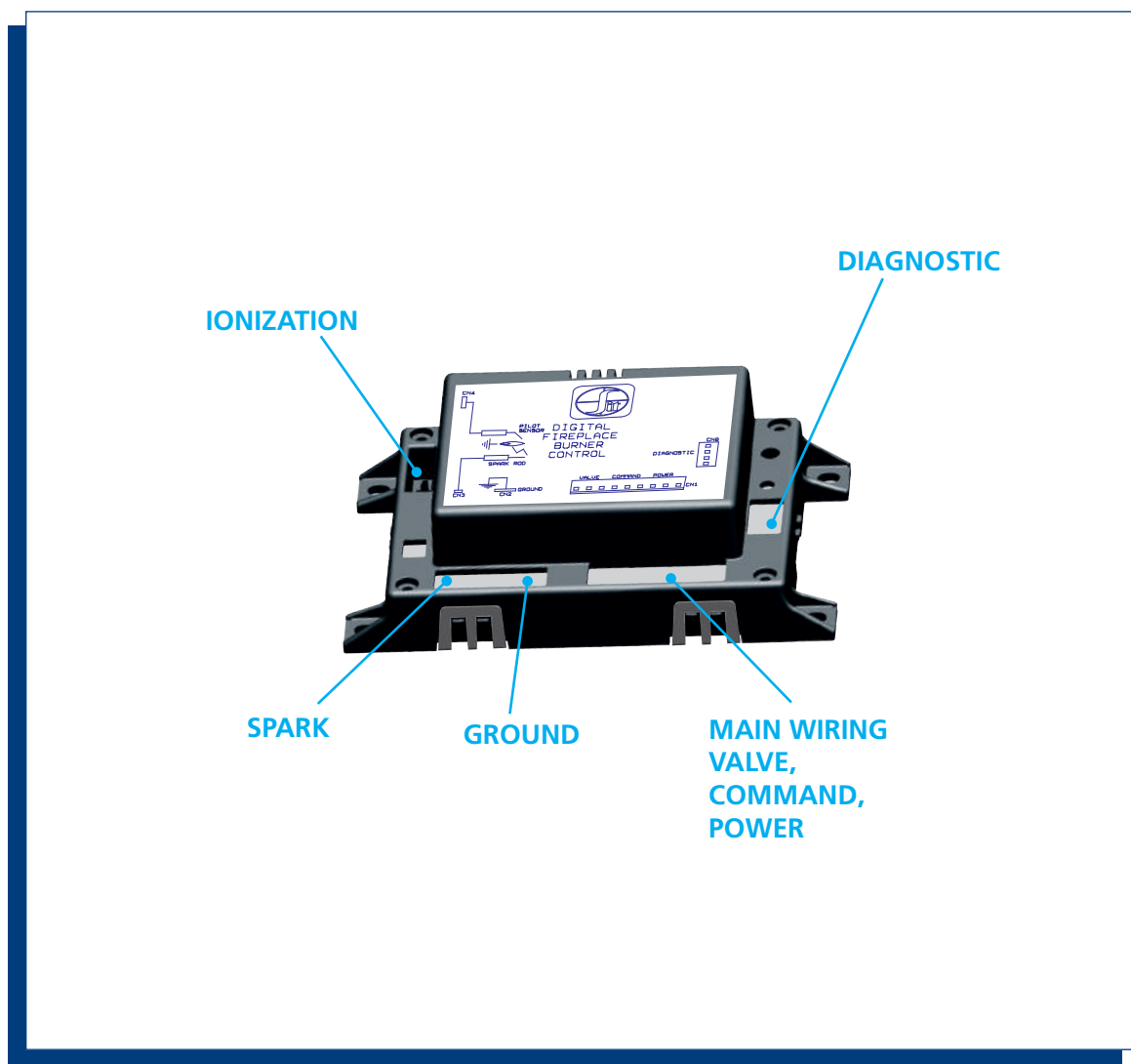

Fig. 4A: Proflame DFC Board.



INSTALLATION

Receiver

The receiver can be placed inside a standard junction type wall box or a low temperature area of the appliance.

Wall Mounting

1. Connect the wiring harness to the back of the receiver.
2. Install the receiver in the Junction box using the existing J box screws. (Fig. 5)
3. Insert the 4 AA type batteries in the battery compartment with the correct polarity.
4. Place the slider into the cover plate.
5. Put the receiver switch in the "OFF" position.
6. Make sure the receiver and cover plate words "ON" and "UP" are on the same side.
7. Align the slider with the switch on the receiver and couple the switch into the slider.
8. Align the screw holes.
9. Using the two (2) screws provided secure the cover plate to the receiver.

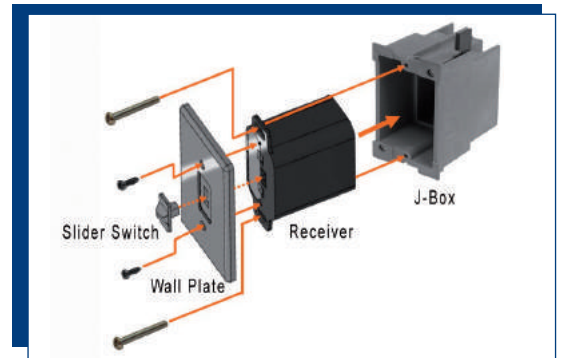

Fig. 5

Hearth Mounting

1. Connect the wiring harness to the back of the receiver.
2. Install the 4 AA type batteries in the battery compartment with the correct polarity.
3. Make sure the receiver and cover plate words "ON" and "UP" are on the same side.
4. Place the slider into the cover plate.
5. Align the slider with the switch on the receiver and couple the switch into the slider.
6. Using the two (2) screws provided secure the cover plate to the receiver.

Fan Control module (PROFLAME GTMF & GTMFS only), and DFC control board

The FCM must be placed in a low temperature area of the appliance.

The Proflame DFC board should be placed in a low temperature area of the appliance.

Connecting to the 880/886 Gas Valve and DFC control board

The electrical connections must be in accordance to Fig. 6A.

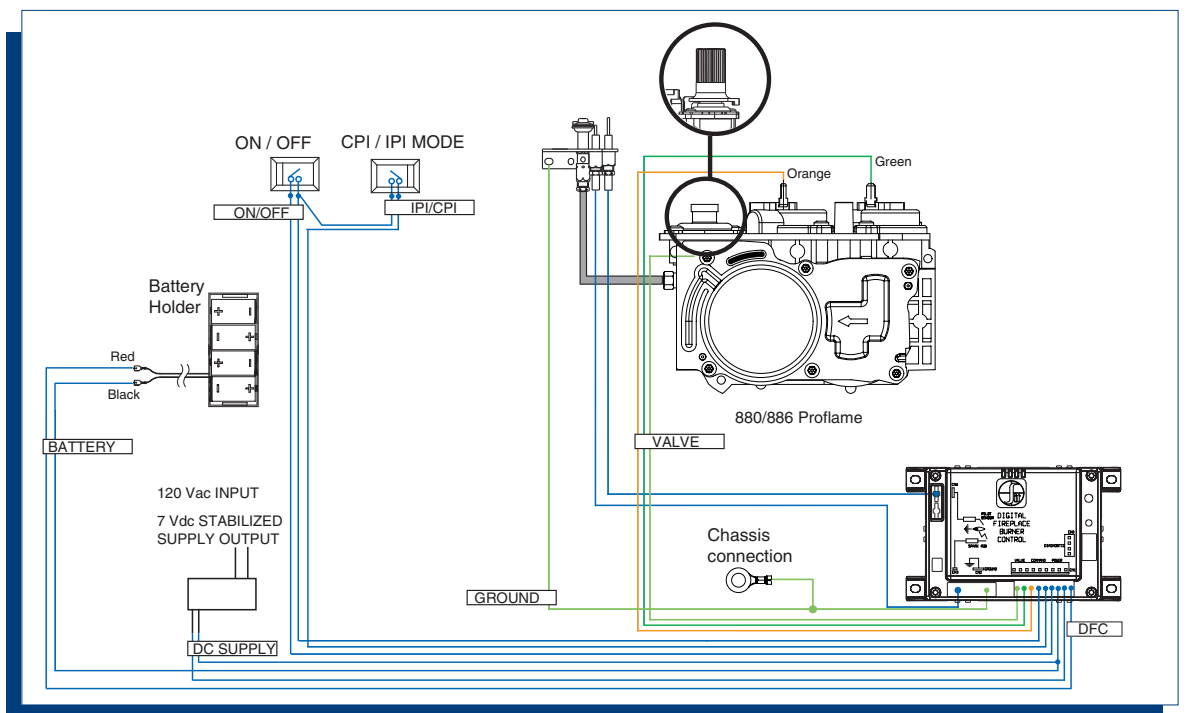

Fig. 6A: Proflame Standalone & 880/886 PROFLAME wiring diagram.

Connecting to the 885 Gas Valve and DFC control board (PROFLAME GTM & GTMS & GTMF & GTMFS only)

The electrical connections must be in accordance to Fig. 6B (GTM & GTMS) or 6C (GTMF & GTMFS).

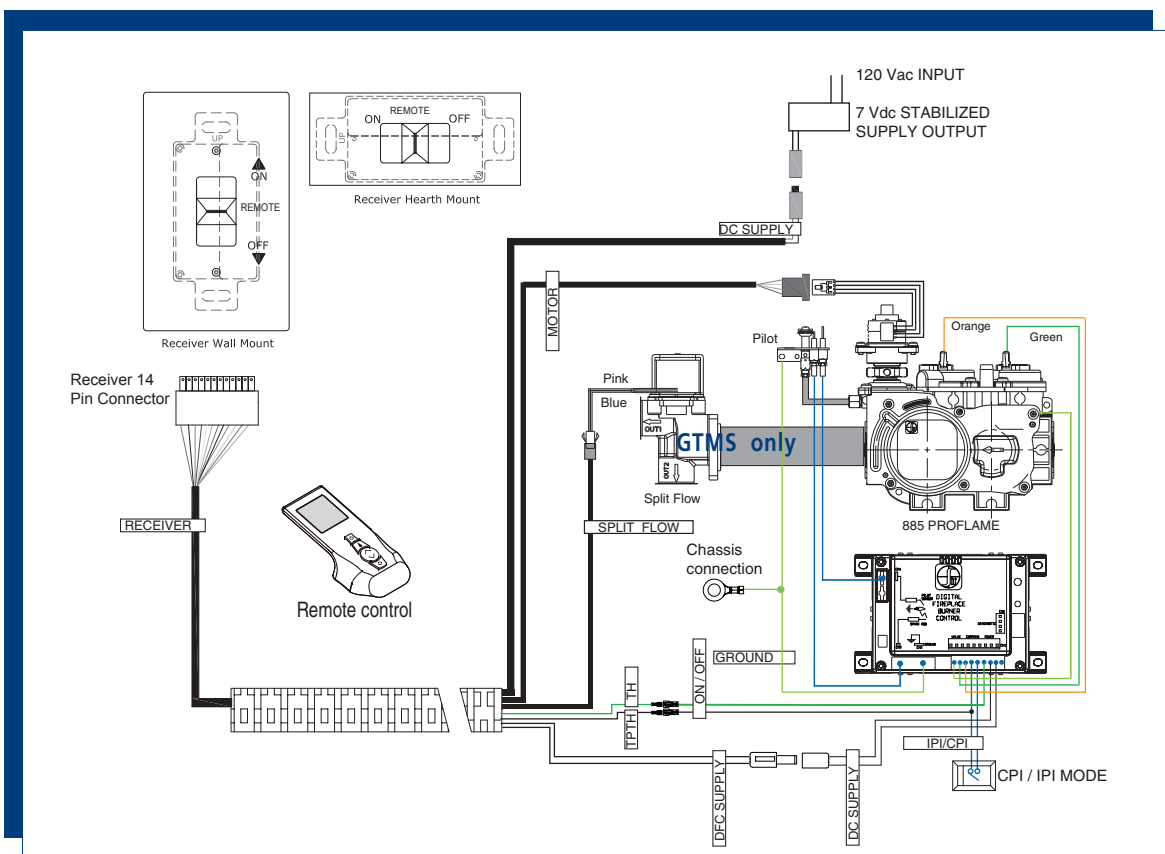

Fig. 6B: Proflame GTM & GTMS & 885 PROFLAME wiring diagram.

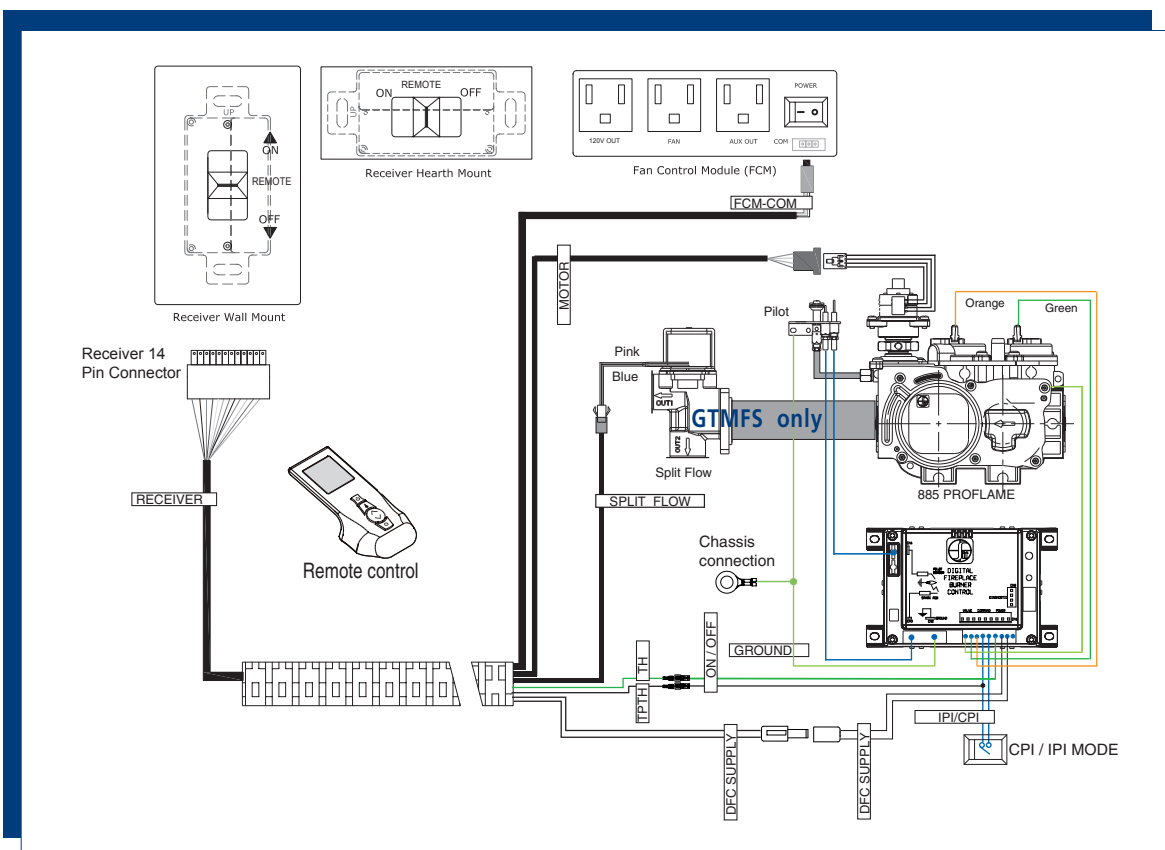

Fig. 6C: Proflame GTMF & GTMFS & 885 PROFLAME wiring diagram.



PRELIMINARY CHECK OF A STANDALONE PROFLAME SYSTEM

Before applying any power supply to the DFC board please verify that the electrical connections are in accordance to Fig. 6A

Initializing the System for the first time

Set the main burner ON/OFF switch to the OFF position.

If installed, set the pilot flame mode selector switch to the IPI position.

Install 4 AA batteries into the battery holder, and respect the polarity indicated on the battery holder silkscreen. Connect the battery holder to the DFC's main wiring harness.

Connect the AC/DC wall adapter to the DFC's DC-jack connector on the main wiring harness, and plug it into the wall mains supply.

Setting the Appliance into Continuous Pilot ignition mode

If installed on the wirings, set the IPI/CPI Pilot Mode Switch to the CPI position (switch closed). At that point the DFC ignition board will immediately complete the ignition sequence for the Pilot Flame, and then will remain with the Pilot Flame ON, waiting for a command to ignite the Main Burner Flame.

Turning ON the Appliance

Close the ON/OFF command contact on the ON/OFF wires, and this will command the DFC ignition board to Turn-ON the appliance's main burner.

Turning OFF the Appliance

Open the ON/OFF command contact on the ON/OFF wires, and this will command the DFC ignition board to Turn-OFF the appliance's main burner.

NOTE: if the Continuous Pilot ignition mode is selected, the Pilot ON Flame will remain. To also turn it completely OFF, switch the appliance into Intermittent Pilot ignition mode, so set the IPI/CPI Pilot Mode Switch to the IPI position (switch opened).

Command definitions

Pilot IPI / CPI switch	Main Turn ON switch	Command reference name	Commanded Fireplace State
Opened, IPI	Opened	Turn-OFF	Flames OFF
Opened, IPI	Closed	Turn-ON	Pilot + Main burner flames ON
Closed, CPI	Opened	Pilot-ON	Pilot flame ON
Closed, CPI	Closed	Turn-ON	Pilot + Main burner flames ON

OPERATING PROCEDURE FOR A REMOTE CONTROL SYSTEM

Initializing the System for the first time

Install the 4 AA batteries into the receiver battery bay. Note the polarity of the battery and insert into the battery bay as indicated on the Battery cover (+/-). Place the 3 position slider switch in the "REMOTE" position. (fig. 3) Insert the end of the paper clip or similar object into the hole marked "PRG" on the Receiver front cover (fig 3). The Receiver will "beep" three (3) times to indicate that it is ready to synchronize with a Transmitter. Install the 3 AAA type batteries in the Transmitter battery bay, located on the base of the Transmitter. With the batteries already installed in the Transmitter, push the ON button. The Receiver will "beep" four times to indicate the Transmitter's command is accepted.

The system is now initialized.

Temperature indication Display

With the system in the "OFF" position, press the Thermostat Key and the Mode Key at the same time. Look at the LCD screen on the Transmitter to verify that a °C or °F is visible to the right of the Room Temperature display. (Fig. 7)

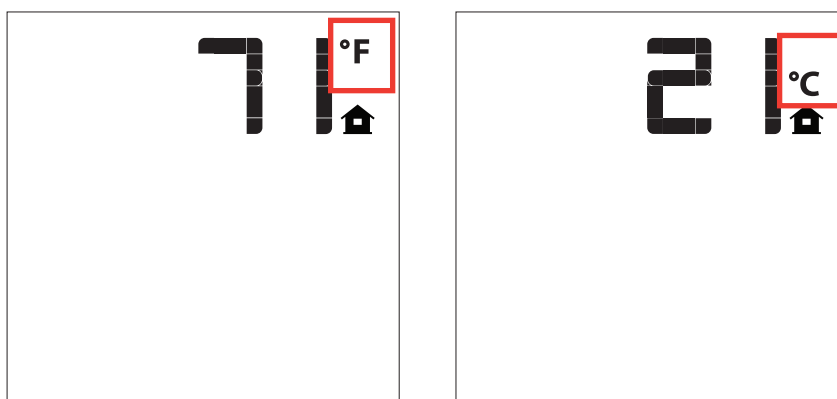

Fig. 7: Remote Control display in Farenheit and Celsius.

Setting the Appliance into Continuous Pilot ignition mode

If installed on the wirings, set the IPI/CPI Pilot Mode Switch to the CPI position (switch closed). At that point the DFC ignition board will immediately complete the ignition sequence for the Pilot Flame, and then will remain with the Pilot Flame ON, waiting for a command to ignite the Main Burner Flame.

Turning ON the Appliance

Press the ON/OFF Key on the Transmitter. The Transmitter display will show all active Icons on the screen. At the same time the Receiver will command the DFC board to start the ignition process. Once the pilot flame is proven the DFC board will open the main valve outlet and the appliance main burner will ignite. A single "beep" from the Receiver will confirm reception of the command.

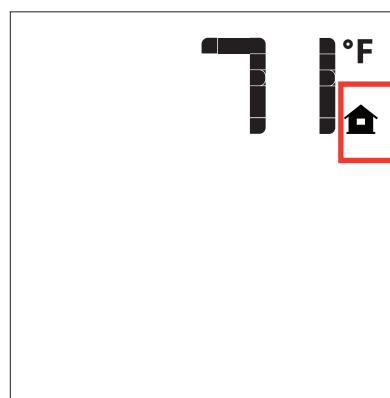

Fig. 8: Remote Control display.

Turning OFF the Appliance

Press the ON/OFF Key on the Transmitter. The Transmitter LCD display will only show the room temperature and Icon (Fig. 8). At the same time the Receiver disconnects will command the DFC board to turn off the burner. Depending on the system model (IPI or CPI) the pilot may shut off (IPI) or remain lit (CPI) and the appliance burner turns OFF. A single "beep" from the Receiver confirms reception of the command.

NOTE: if the Continuous Pilot ignition mode is selected, the Pilot ON Flame will remain. To also turn it completely OFF, switch the appliance into Intermittent Pilot ignition mode, so set the IPI/CPI Pilot Mode Switch to the IPI position (switch opened).



Flame Height Control

Proflame GT: with the system on, and the flame present in the appliance, pressing the Down Arrow Key (Fig. 1) will turn OFF the flame while the remote system is still on. If the Up Arrow Key is pressed while in the above described state the flame will come on. (Fig. 9A & 9D)

Proflame GTM & GTMF: has six (6) flame levels. With the system on, and the flame level at the maximum in the appliance, pressing the Down Arrow Key (Fig. 1) once will reduce the flame height by one step until the flame is turned OFF.

The Up Arrow Key will increase the flame height each time it is pressed. If the Up Arrow Key is pressed while the system is on but the flame is off, the flame will come on in the high position. (Fig. 9A & 9B & 9C & 9D) A single "beep" will confirm reception of the command.

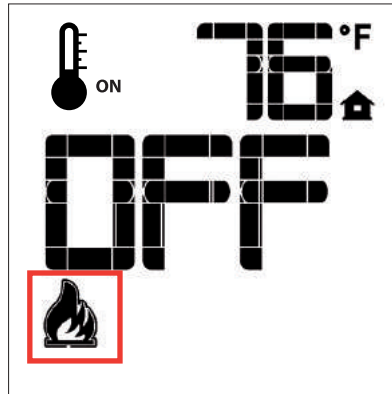

Fig. 9A: Flame Off

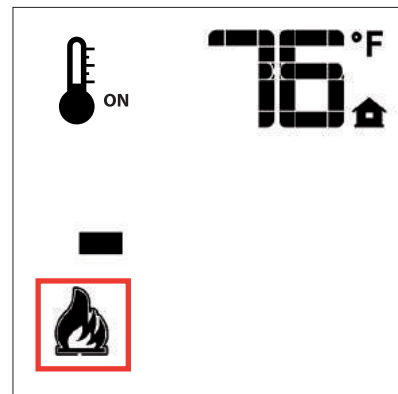

Fig. 9B: Flame Level 1

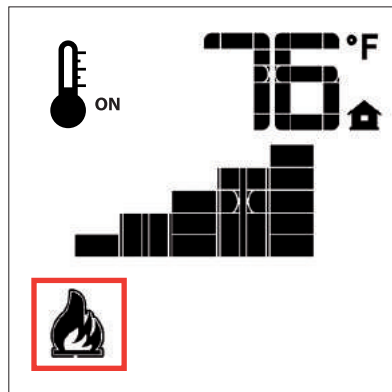

Fig. 9C: Flame level 5

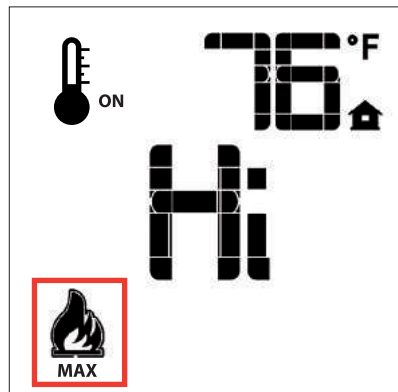

Fig. 9D: Flame Level Maximum

Split flow function (GTMS & GTMFS only)

The secondary burner is controlled by the split Flow. To activate this function use the Mode Key (Fig. 1) to index to the SPLIT FLOW icon (Fig. 9E & 9F). Pressing the Up Arrow Key will activate the secondary burner. Pressing the Down Arrow Key will turn the secondary burner OFF. A single "beep" will confirm the reception of the command.



Fig. 9E

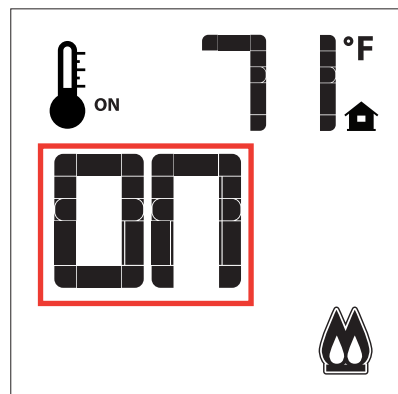

Fig. 9F

Room Thermostat (Transmitter Operation)

The Remote Control can operate as a room thermostat. The thermostat can be set to a desired temperature to control the comfort level in a room.

To activate this function, press the Thermostat Key (Fig. 1). The LCD display on the Transmitter will change to show that the room thermostat is "ON" and the set temperature is now displayed (Fig. 10). To adjust the set temperature, press the Up or Down Arrow Keys until the desired set temperature is displayed on the LCD screen of the Transmitter (Fig. 11).

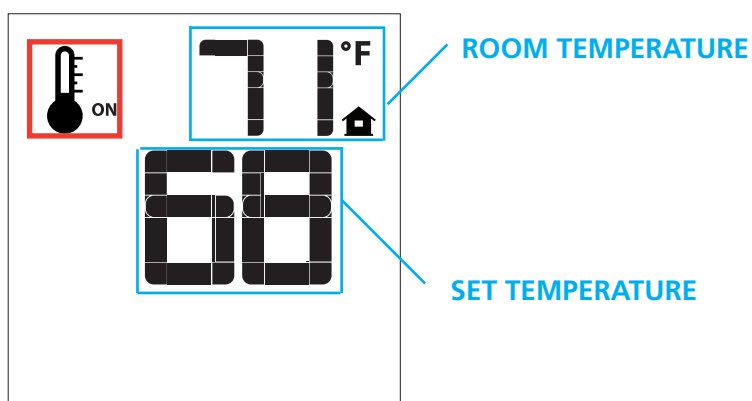

Fig. 10

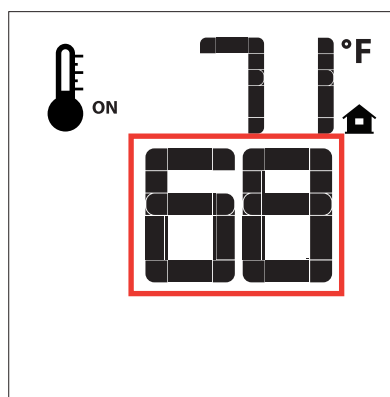

Fig. 11

Smart Thermostat (Transmitter Operation) (Proflame GTM & GTMF & GTMFS only)

The Smart Thermostat function adjusts the flame height in accordance to the difference between the set point temperature and the actual room temperatures. As the room temperature gets closer to the set point the Smart Function will modulate the flame down. To activate this function, press the Thermostat Key (Fig. 1) until the word "SMART" appears to the right of the temperature bulb graphic (Fig. 12). To adjust the set temperature, press the Up or Down Arrow Keys until the desired set temperature is displayed on the LCD screen of the Transmitter (Fig. 13).

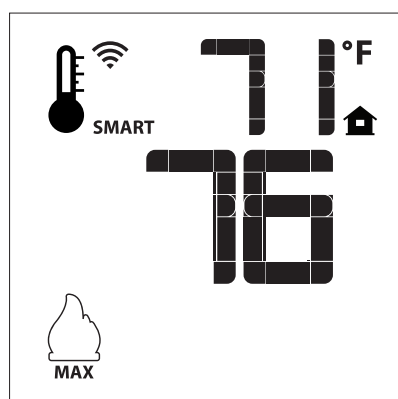

Fig. 12: Smart flame function

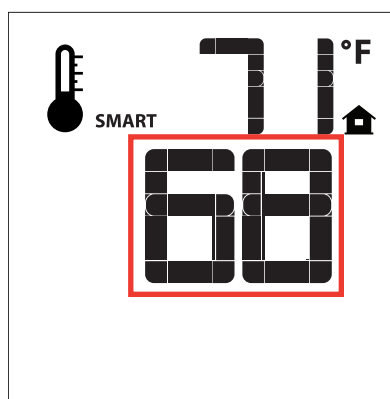

Fig. 13



Fan Speed Control (Proflame GTMF & GTMFS only)

If the appliance is equipped with a hot air circulating fan, the speed of the fan can be controlled by the Proflame system. The fan speed can be adjusted through six (6) speeds. To activate this function use the Mode Key (fig.1) to index to the fan control icon (Fig. 14). Use the Up/Down Arrow Keys (Fig.1) to turn on, off or adjust the fan speed (fig. 15). A single "beep" will confirm reception of the command.

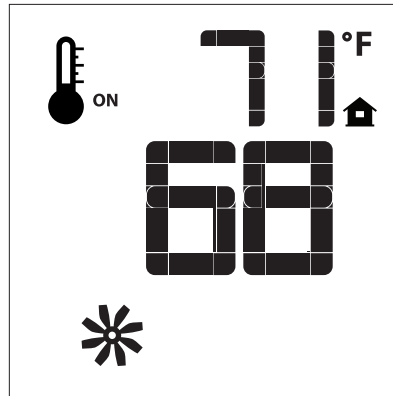

Fig. 14

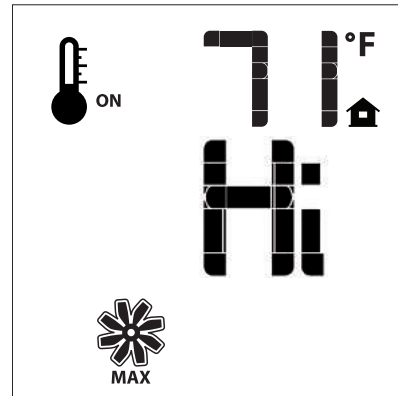

Fig. 15

Remote Actuated 120V Auxiliary Outlet (Proflame GTMF & GTMFS only)

The auxiliary function controls the AUX power outlet on the Fan Control Module. To activate this function use the Mode Key (fig. 1) to index to the AUX icon (fig. 16 & 17). Pressing the Up Arrow Key will activate the outlet. Pressing the Down Arrow Key will turn the outlet off. A single "beep" will confirm the reception of the command.



Fig. 16

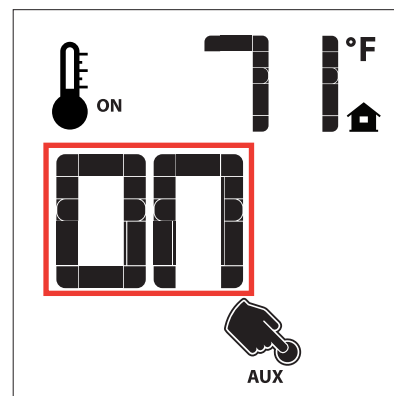

Fig. 17

Key lock

This function will lock the keys to avoid unsupervised operation.

To activate this function, press the MODE and UP keys at the same time (Fig. 18).

To de-activate this function, press the MODE and UP keys at the same time.

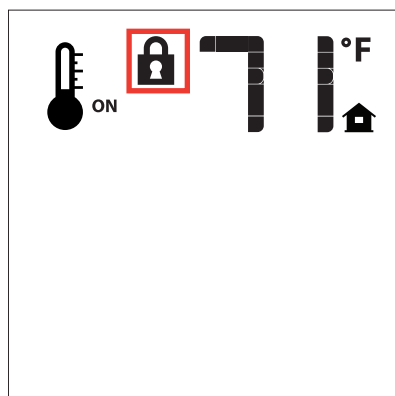

Fig. 18

Low Battery Power detection

Transmitter

The life span of the remote control batteries depends on various factors: quality of the batteries used, the number of ignitions of the appliance, the number of changes to the room thermostat set point, etc.

When the transmitter batteries are low, an Icon will appear on the LCD display of the transmitter (Fig. 19) before all battery power is lost. When the batteries are replaced this Icon will disappear.

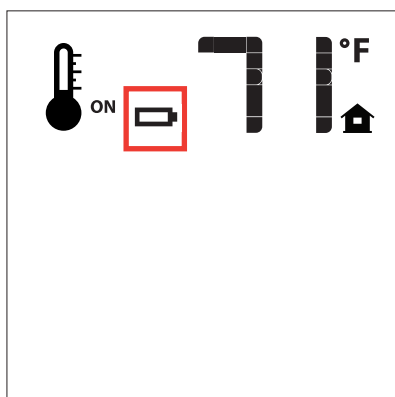

Fig. 19

Receiver

The life span of the receiver batteries depends on various factors: quality of the batteries used, the number of ignitions of the appliance, the number of changes to the room thermostat set point, etc.

When the receiver batteries are low, No "beep" will be emitted from the receiver when it receives an On/Off command from the transmitter. This is an alert for a low battery condition for the receiver. When the batteries are replaced the "beep" will be emitted from the receiver when the ON/OFF key is pressed (See Initialization of The System).



Manual override

If the batteries of the Receiver or Transmitter are low or depleted, the appliance can still be turned on manually by sliding to the "ON" position the three position slider switch on the Receiver. This will bypass the remote control feature of the system and the appliance main burner will Turn-ON.

APPENDIX

Command definitions

Pilot IPI / CPI switch	Position of the receiver slider switch	Command reference name	Commanded Fireplace State
Opened, IPI	"OFF" "REMOTE" and "OFF received"	Turn-OFF	Flames OFF
Opened, IPI	"ON" "REMOTE" and "ON received"	Turn-ON	Pilot + Main burner flames ON
Closed, CPI	"OFF" "REMOTE" and "OFF received"	Pilot-ON	Pilot flame ON
Closed, CPI	"ON" "REMOTE" and "ON received"	Turn-ON	Pilot + Main burner flames ON

DIMENSIONAL DRAWINGS

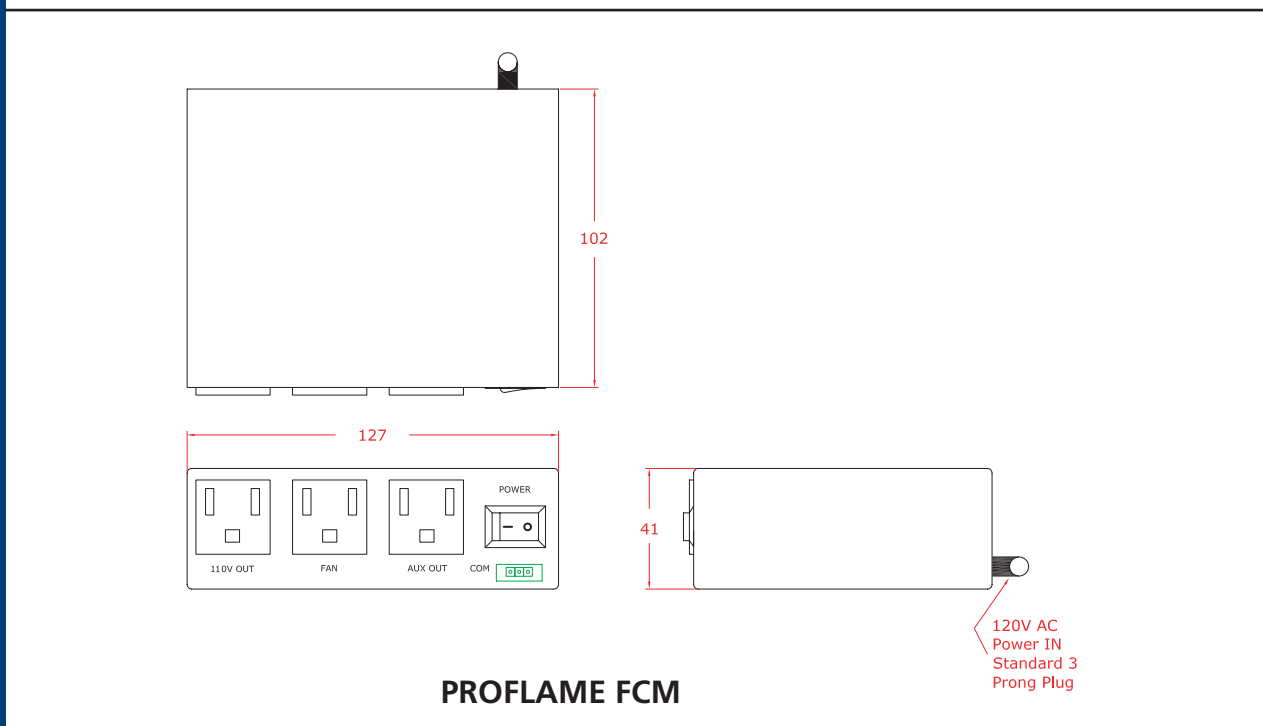
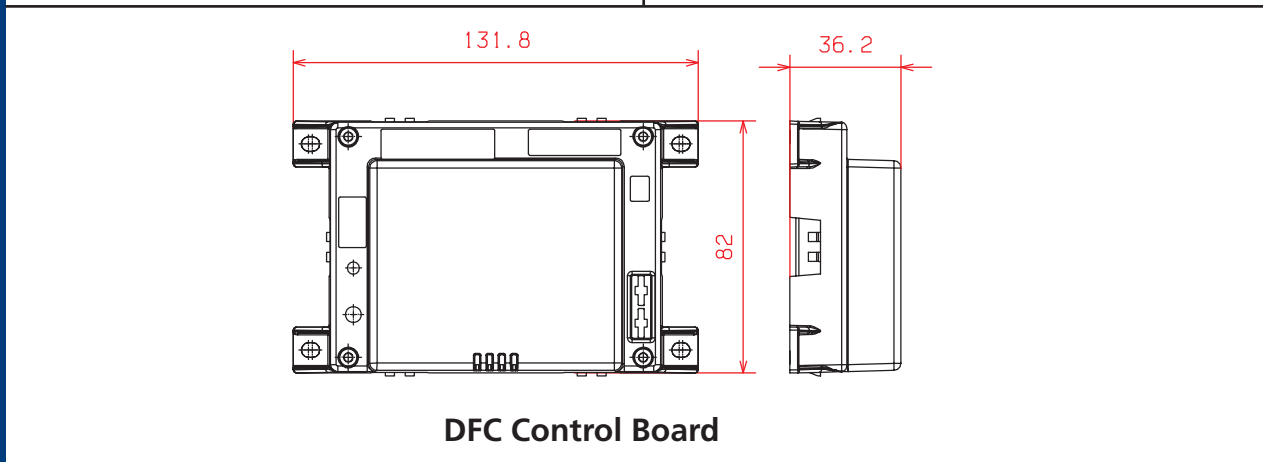
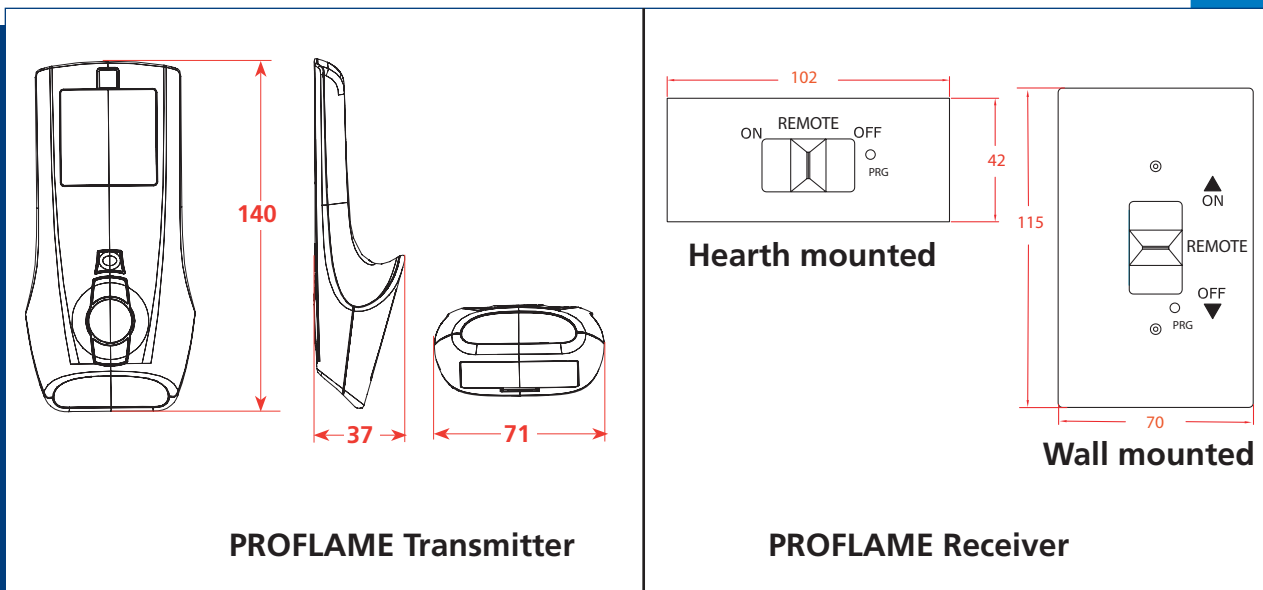

Dimensions are in millimeters



SITGroup

SIT La Precisa S.p.A.

Viale dell'Industria 31-33

35129 PADOVA - ITALY

Tel. +39/049/829.31.11, Fax +39/049/807.00.93

www.sitgroup.it - e-mail: mkt@sitgroup.it
