Compatibility

- Avalon Newport PS and Newport Bay PI (Avanti PS & PI)
- Avalon Astoria PS and Astoria Bay PI
- Avalon Arbor PS
- Lopi Pioneer PS and Pioneer Bay PI (Heritage PS & PI)
- Lopi Yankee PS and Yankee Bay PI
- Lopi Leyden PS

Packing List

- Control Board
- Molex Jumper

Overview

This control board is compatible with all large and small pellet heaters manufactured from 1997. Circuitry on the board allows it to be programmed for either the large or small pellet heaters (these heaters use different voltage settings). See “Configuring the Control Board” for details. It also includes a diagnostic feature that allows the end user to diagnose common problems without having to inspect the wiring or components. The indicator lights on the control board will display a maintenance code after a problem has been detected. See “Diagnostic Codes” for details. NOTE: the new wiring harness (250-00017) is required to utilize this feature.

Configuring the Control Board

Configuring for Large or Small Heaters

The control board is initially configured for the large heaters (Astoria, Yankee, Arbor, and Leyden). To change the configuration the control board must be in the off position plugged into a cold stove, (no lights or running components) with the jumper molex removed (see the illustration below). In this condition press and hold the manual auger button down and press both fan up and fan down arrow keys at the same time. All heat output lights will flash. One flash denotes the large pellet heater configuration. Two flashes denote the small pellet heater configuration (Newport and Pioneer models). Repeat pressing the keys until the correct configuration is obtained.

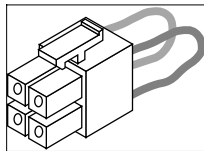

250-00012

Using this Control Board with Older Wiring Harnesses

When the control board is installed on an older wire harness the 4 pin molex jumper plug on the back of the control board next to the stock wire harness must be installed. This jumper replaces the diagnostic wires (see “Wiring Diagram”) that are present on the new wiring harness. The control board will work normally, but the diagnostic capabilities will not function.



Pellet Control Board Installation Instructions

250-00011

Technical Notes for Operation

Make sure to give the home owner the “Pellet Heater Operating and Troubleshooting Instructions” if you are replacing an older board (the final 5 pages of this instruction sheet). It contains the new operating instructions for this control board.

A few changes were made to accommodate the new control board. The start up cycle indicator on the old board illuminates all heat output indicator lights to show the unit is in a start-up cycle and adjusting the heat setting knob would not change them. On the new board to enable adjusting the run settings during start-up we made the start-up indicator the blinking #1 heat output light. If the #1 heat output light is blinking the board is in a start-up mode and the blower and auger outputs can not be adjusted. The run settings the unit will go to after start-up are displayed on the heat output indicator. These settings can be adjusted any time during start up by pushing the up or down heat buttons on the panel. When the fan setting is adjusted up or down the heat output indicators will turn off and the fan setting will display.

Another feature we added to the control board is a manual auger feed. This button can be used to prime and empty the auger or speed the initial delivery of pellets to the burn pot. All start-up timing remains the same and the stove will still self prime the auger tube – this option allows the operator an additional option. It is not needed for normal operation.

All voltage outputs and feed rates remain the same as the old board. There is a difference in respect to the auger on/off times. The auger timing was changed to shorten the interval between pellet drops to the burn pot. For example, on low the auger used to turn for 3 seconds and remain off for 13 seconds, for this same condition this control board turns the auger for 2.5 seconds and remains off for 10.7 seconds. This produces the same amount of time the auger is turning and not turning but gives a steadier flame height and less incidental outages on low.

Wiring Diagram (new, 2005 version – 250-00017)

Pellet Wiring Diagram

(wiring harness 250-00017)

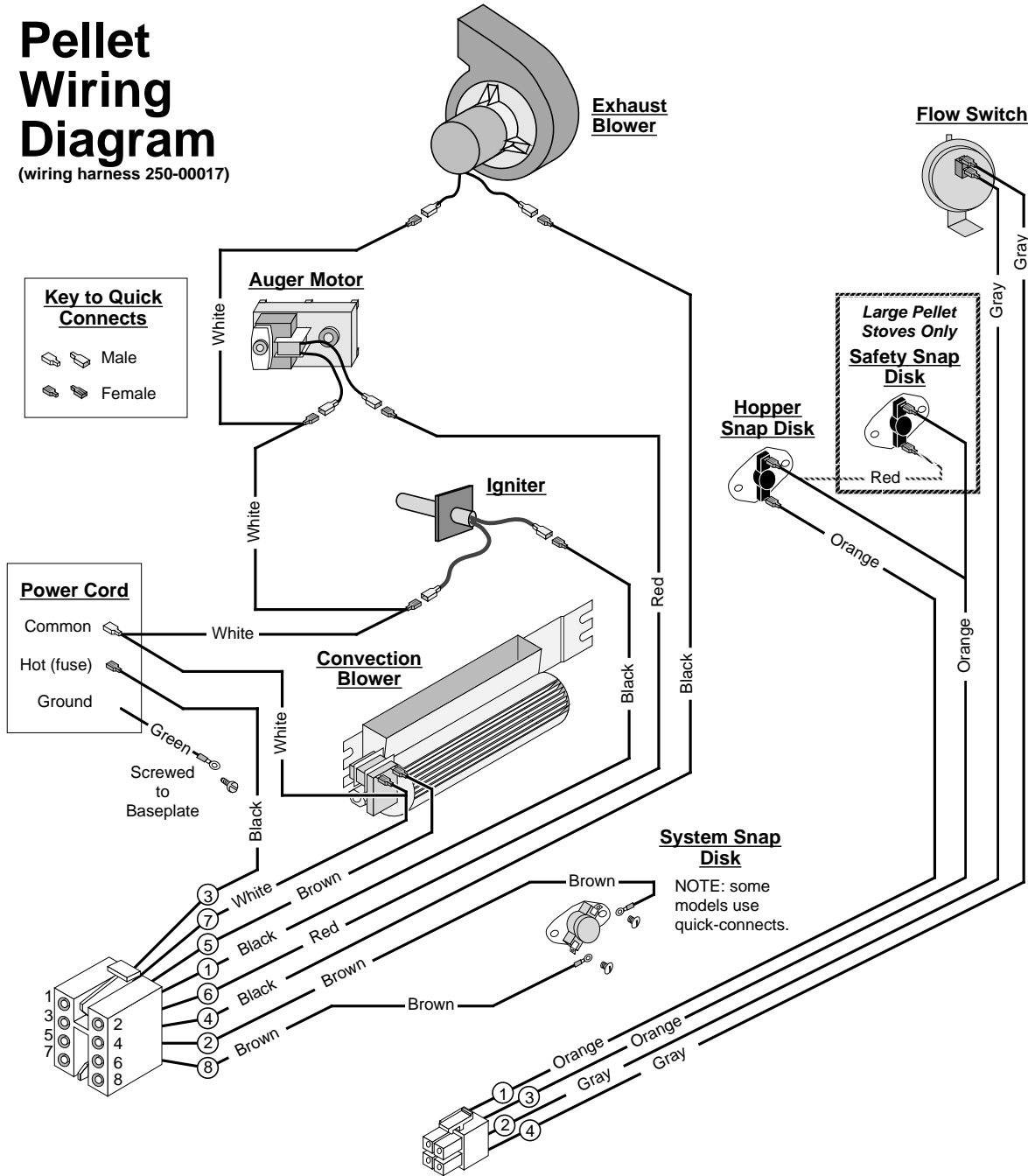

Wiring Diagram (older version – 100-00393 - B Rev)

NOTE: Wire coloring may not be identical to this diagram.

Pellet Wiring Diagram

(wiring harness 100-00393B)

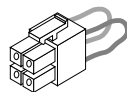
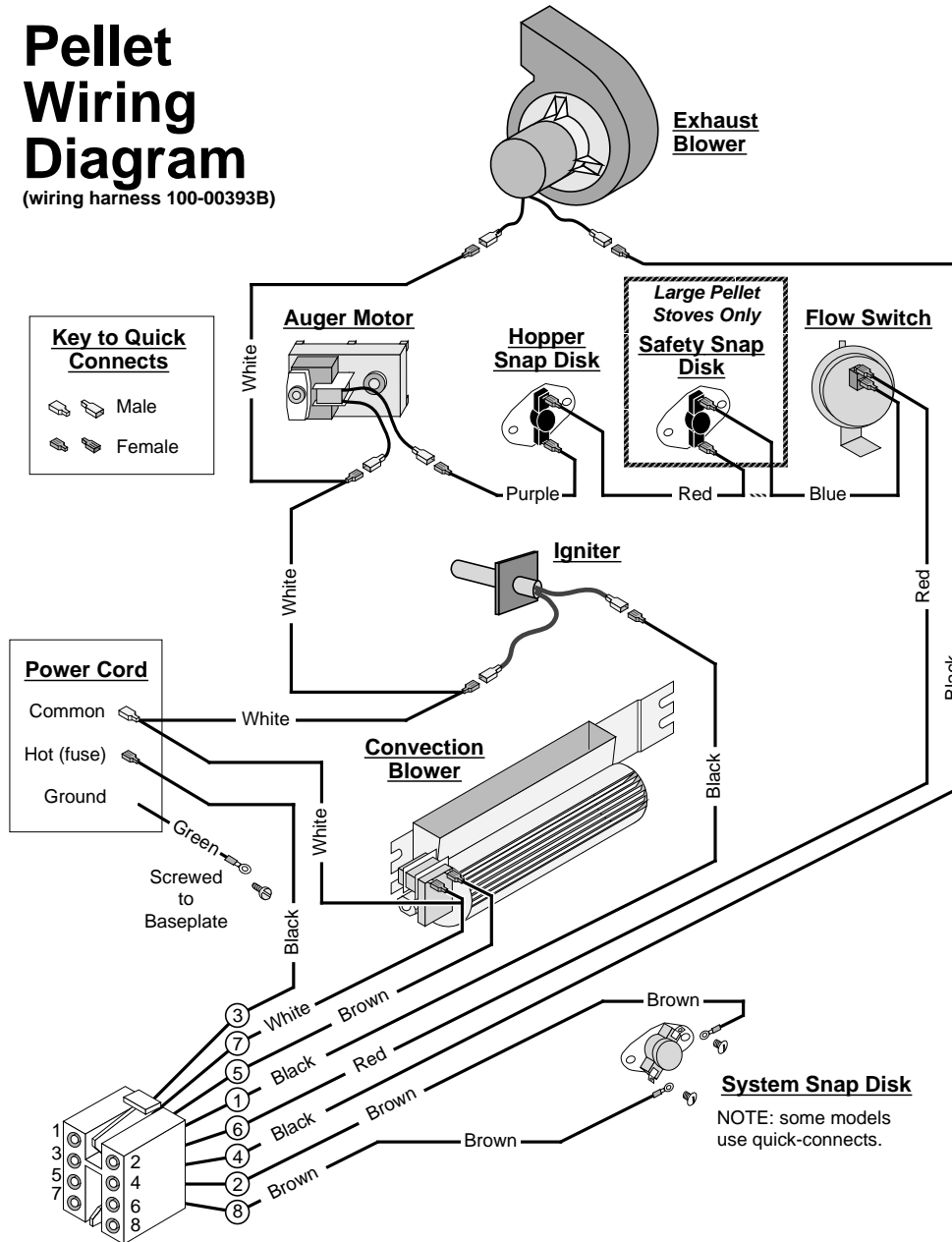

NOTE: Make sure the jumper plug is installed when using the AVR control board with this wiring harness.

The Two Modes of Operation:

Manual

Manual mode requires the user to turn the heater on and off manually.

Auto (requires a thermostat)

Auto mode allows you to use a thermostat to control room temperature. The stove automatically turns on when the temperature drops below the thermostat setting. Once the stove reaches operating temperature, the stove then runs at the heat output setting selected.

Switching Modes While in Operation

Whenever the stove is switched from one mode to another while in operation, the stove will enter the "start-up" sequence for a minimum of 20 minutes.

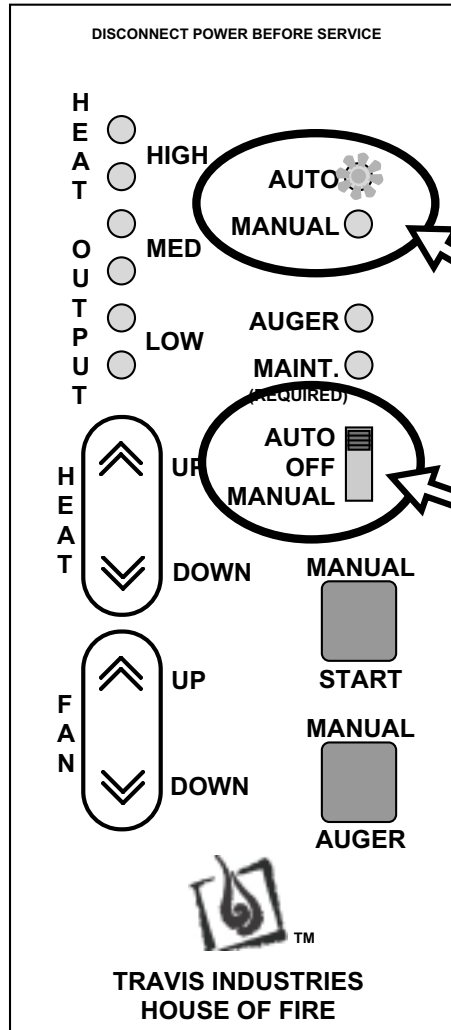

These indicator lights are used to determine which mode you are in.

Use the mode switch to determine the mode.

Pellet Heater Operating and Troubleshooting Instructions

Manual Mode

Manual mode requires the user to turn the heater on and off manually.

To Start

Press the "Manual Start" button. That's it. The stove automatically goes to a medium burn rate and high fan while the igniter starts the fire burning within 10 minutes. During this period the lowest "HEAT OUTPUT" light will flash. If the stove does not start in 30 minutes, the stove turns off.

Once up to temperature, the stove will then run at the heat output setting selected on the control panel (see "To Adjust the Heat" below).

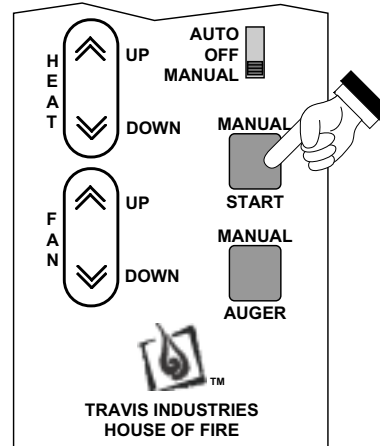

To Shut Down

Move the mode switch to "OFF". The exhaust blower will still run until the heater cools down.

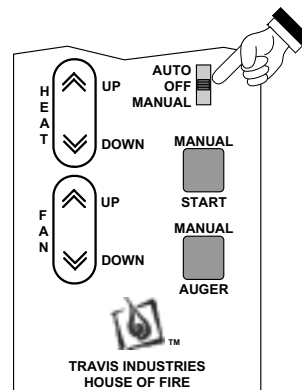

To Adjust the Heat

Press the "Heat" buttons to adjust the heat output.

NOTE: During start-up you may adjust the heat setting. This heat setting will take affect once the start-up sequence is complete.

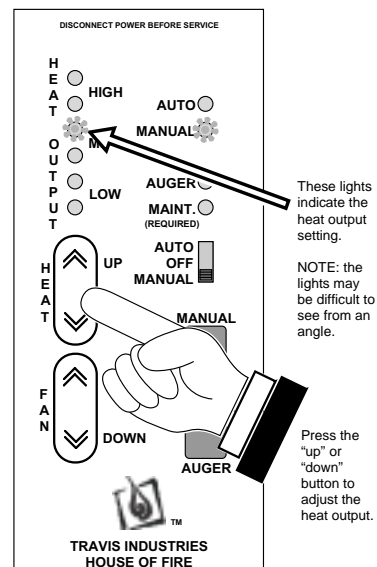

Pellet Heater Operating and Troubleshooting Instructions

Auto Mode

Auto mode allows you to use a thermostat to control room temperature. The stove automatically turns on when the temperature drops below the thermostat setting. Once the stove reaches operating temperature, the stove then runs at the heat output setting selected.

To Adjust Room Temperature (or Start the Stove)

Move the thermostat to the heat setting desired. If the room is cooler than the setting, the stove will go through the start-up sequence for approximately 10 minutes. During this period the lowest "HEAT OUTPUT" light will flash. Once up to temperature, the stove will then run at the heat output setting selected on the control panel. If the room is too hot, move the thermostat to a lesser setting.

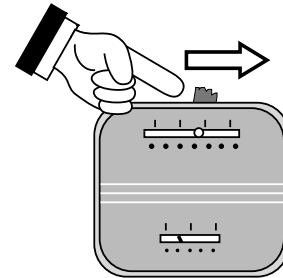

To Adjust the Heat

Press the "Heat" buttons to adjust the heat output.

HINT:

If you find that the stove turns on and off repeatedly, you may wish to turn the heat output to a lesser setting. The lower setting will provide a more consistent heat output over time, eliminating the need for the thermostat to repeatedly turn the stove off.

NOTE:

If the thermostat calls for heat while the stove is still cooling down, the stove will go through the start-up sequence (for a minimum of 20 minutes).

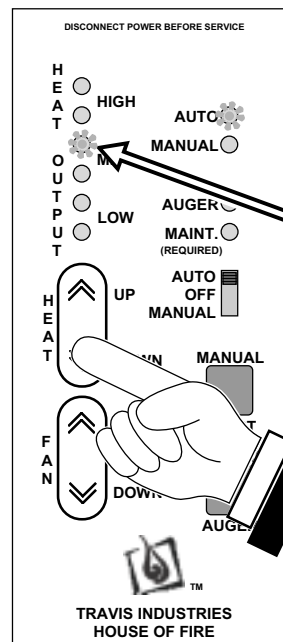

These lights indicate the heat output setting.

NOTE: the lights may be difficult to see from an angle.

Press the "up" or "down" button to adjust the heat output.

To Shut Down

Move the mode switch to "OFF". The exhaust blower will still run until the heater cools down.

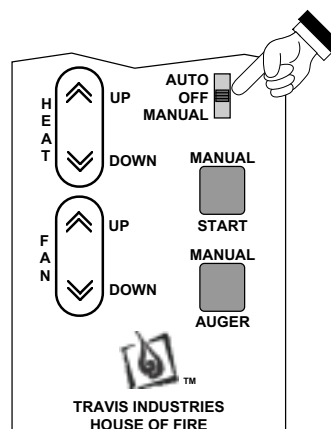

Adjusting the Fan Speed

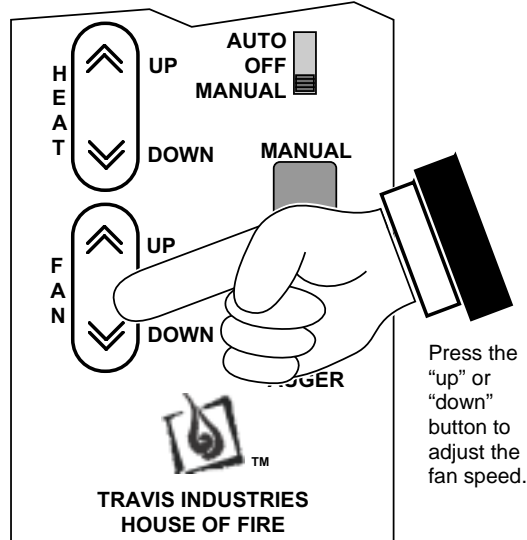

Press the
"up" or
"down"
button to
adjust the
fan speed.

NOTE: When you press the Fan speed buttons the "Heat Output" lights will indicate fan speed (not "Heat Output"). After a few seconds the "Heat Output" lights will go back to displaying the heat output setting.

Pellet Heater Operating and Troubleshooting Instructions

"Maintenance Required" Light

NOTE: If the "MAINTENACE REQUIRED" light comes on, check the items below **before calling for service**.

The "MAINTENACE REQUIRED" light is used to indicate maintenance is required on the heater. It will turn on due to various operating circumstances. When it turns on, a second light will turn on near "HEAT OUTPUT" (see the illustration to the right). Determine the maintenance code (2, 4, or 6), then use the chart below to diagnose and remedy the situation.

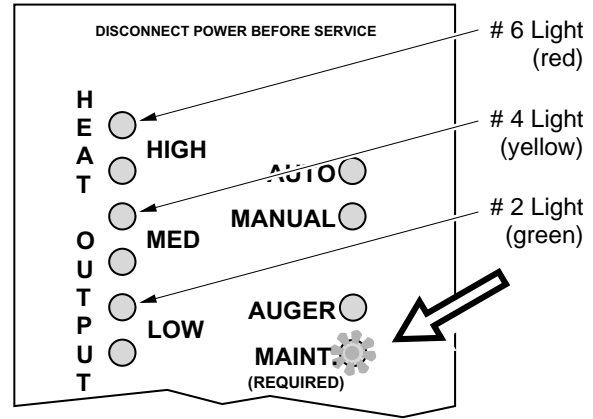

| Light | Likely Cause | Remedy (see owner's manual for details) |
|------------|---|---|
| 2 (green) | <ul style="list-style-type: none"> • Heavy Ash Build-Up in Exhaust Duct • Heavy Ash Build-Up in Exhaust Housing or Plugged Tubing • Heavy Ash Build-Up in Vent | <ul style="list-style-type: none"> • Clean the Firebox • Clean the Exhaust Housing and Tubing • Clean the Vent |
| 4 (yellow) | <ul style="list-style-type: none"> • Heater Ran Out of Pellets • Heater Did Not Start-Up Correctly • Power Outage • Restrictor Not Set Properly • Burnpot Clogged • Air Leak • Heavy Ash Build-Up • Auger Drop Tube Plugged | <ul style="list-style-type: none"> • Refill the Hopper • Re-Start the Heater and Verify the Pellets Ignite after 10 Minutes • Re-Start the Heater • Re-Start the Heater and Monitor Restrictor Setting • Clean Burnpot • Verify Door, Glass, and Ashpan Seal Correctly • Clean the Firebox, Exhaust Housing, and Vent • Clear the Auger Drop Tube |
| 6 (red) | <ul style="list-style-type: none"> • Electrical Input Error (voltage or mhz fluctuation, amp deficiency, etc.) • Components Over-Heated • Faulty Wiring / System Fault | <ul style="list-style-type: none"> • Unplug the Heater then Plug it Back In (this re-starts the circuit board) • Clean the Heater and Vent (a plugged heater will slow exhaust flow, increasing temperatures) • If this Fault Persists, Contact Your Dealer |