

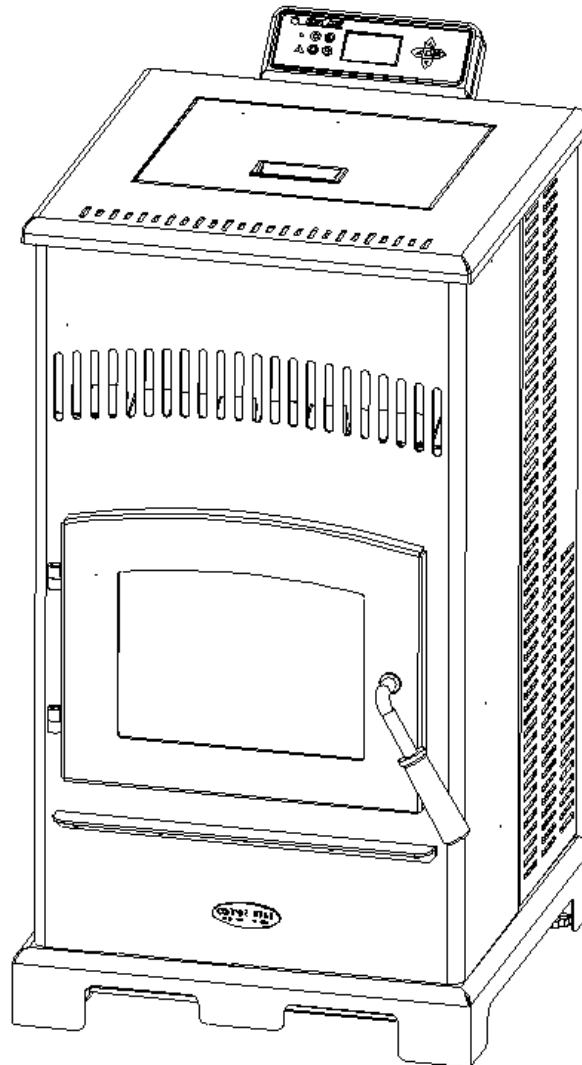

Operator's Manual
HP55
Pellet Stove



WARNING

PLEASE READ THIS ENTIRE MANUAL BEFORE INSTALLATION AND USE OF THIS PELLET FUEL-BURNING ROOM HEATER. FAILURE TO FOLLOW THESE INSTRUCTIONS COULD RESULT IN PROPERTY DAMAGE, BODILY INJURY OR EVEN DEATH



CAUTION DO NOT DISCARD!

- IMPORTANT OPERATING AND MAINTENANCE INSTRUCTIONS INCLUDED.
- SAVE THESE INSTRUCTIONS AND LEAVE THIS MANUAL WITH ANY PARTY RESPONSIBLE FOR USE AND OPERATION



CAUTION

CONTACT LOCAL BUILDING OR FIRE OFFICIALS ABOUT RESTRICTIONS AND INSTALLATION INSPECTION REQUIREMENTS FOR YOUR AREA.

HP55

Revised 09-21-19

©2019 SMG Hearth and Home LLC

All Rights Reserved



WARNING

PLEASE READ THIS ENTIRE MANUAL BEFORE INSTALLATION AND USE OF THIS PELLET FUEL-BURNING ROOM HEATER. FAILURE TO FOLLOW THESE INSTRUCTIONS COULD RESULT IN PROPERTY DAMAGE, BODILY INJURY OR EVEN DEATH.

- DO NOT STORE OR USE GASOLINE OR OTHER FLAMMABLE VAPORS AND LIQUIDS IN THE VICINITY OF THIS OR ANY OTHER APPLIANCE.
- DO NOT OVERFIRE - IF ANY EXTERNAL PART STARTS TO GLOW, YOU ARE OVERFIRING. REDUCE FEED RATE. OVERFIRING WILL VOID THE WARRANTY.
- COMPLY WITH ALL MINIMUM CLEARANCES TO COMBUSTIBLES AS SPECIFIED. FAILURE TO COMPLY MAY CAUSE A HOUSE FIRE



WARNING

HOT! DO NOT TOUCH. SEVERE BURNS MAY RESULT. CLOTHING IGNITION MAY RESULT. GLASS AND OTHER SURFACES ARE HOT DURING OPERATION AND COOL DOWN.

- KEEP CHILDREN AWAY.
- CAREFULLY SUPERVISE CHILDREN IN SAME ROOM AS APPLIANCE.
- DO NOT OPERATE WITH PROTECTIVE BARRIERS OPEN OR REMOVED.
- KEEP CLOTHING, FURNITURE, DRAPERIES AND OTHER COMBUSTIBLES AWAY.



CAUTION

CHECK BUILDING CODES PRIOR TO INSTALLATION. CONTACT THE REGULATING AUTHORITY PRIOR TO INSTALLATION TO DETERMINE THE NEED FOR A PERMIT.

- INSTALLATION MUST COMPLY WITH LOCAL, REGIONAL, STATE AND NATIONAL CODES AND REGULATIONS
- CONSULT LOCAL BUILDING OR FIRE OFFICIALS ABOUT RESTRICTIONS AND INSTALLATION INSPECTION REQUIREMENTS IN YOUR AREA.



CAUTION

DO NOT DISCARD!

- IMPORTANT OPERATING AND MAINTENANCE INSTRUCTIONS INCLUDED.
- READ, UNDERSTAND AND FOLLOW THESE INSTRUCTIONS FOR SAFE INSTALLATION AND OPERATION.
- LEAVE THIS MANUAL WITH PARTY RESPONSIBLE FOR USE AND OPERATION.



CAUTION

TESTED AND APPROVED FOR PELLET FUEL. BURNING ANY OTHER TYPE OF FUEL VOIDS WARRANTY.

WARNINGS AND SAFETY PRECAUTIONS

OWNER'S RESPONSIBILITY

Accurate assembly and safe and effective use of the stove is the owners responsibility.

- Read and follow all safety instructions.
- Carefully follow all assembly instructions.
- Maintain the stove according to directions and schedule included in this operators manual.
- Ensure that anyone who uses the stove is familiar with all controls and safety precautions

SPECIAL MESSAGES

Your manual contains special messages to bring attention to potential safety concerns, stove damage as well as helpful operating and servicing information. Please read all the information carefully to avoid injury and stove damage

NOTE: General information is given throughout the manual that may help the operator in the operation or service of the stove.

IMPORTANT SAFETY PRECAUTIONS

Please read this section carefully. Operate the stove according to the safety instructions and recommendations outlined here and inserted throughout the text. Anyone who uses this stove must read the instructions and be familiar with the controls



This symbol points out important safety instructions which if not followed could endanger your personal safety. Read and follow all instructions in this manual before attempting to operate this equipment.



DANGER

DANGER INDICATES A SERIOUS INJURY OR FATALITY WILL RESULT IF THE SAFETY INSTRUCTIONS THAT FOLLOW THIS SIGNAL WORD ARE NOT OBEYED.



WARNING

WARNING INDICATES A SERIOUS INJURY OR FATALITY COULD RESULT IF THE SAFETY INSTRUCTIONS THAT FOLLOW THIS SIGNAL WORD ARE NOT OBEYED.



CAUTION

CAUTION INDICATES YOU CAN OR YOUR EQUIPMENT CAN BE HURT IF THE SAFETY INSTRUCTIONS THAT FOLLOW THIS SIGNAL WORD ARE NOT OBEYED.



IMPORTANT

IMPORTANT INDICATES HELPFUL INFORMATION FOR PROPER ASSEMBLY, OPERATION, OR MAINTENANCE OF YOUR EQUIPMENT.



WARNING

YOU MUST READ, UNDERSTAND AND COMPLY WITH ALL SAFETY AND OPERATING INSTRUCTIONS IN THIS MANUAL BEFORE ATTEMPTING TO SETUP AND OPERATE YOUR STOVE.

FAILURE TO COMPLY WITH ALL SAFETY AND OPERATING INSTRUCTIONS CAN RESULT IN SERIOUS PERSONAL INJURY TO YOU AND/OR BYSTANDERS, AND RISK OF EQUIPMENT AND PROPERTY DAMAGE. THE TRIANGLE IN THE TEXT SIGNIFIES IMPORTANT CAUTIONS OR WARNINGS WHICH MUST BE FOLLOWED.

WARNING

WARNING INDICATES A SERIOUS INJURY OR FATALITY COULD RESULT IF THE SAFETY INSTRUCTIONS THAT FOLLOW THIS SIGNAL WORD ARE NOT OBEYED.

- Read this entire manual before you install and use your new pellet stove. Failure to follow instructions may result in property damage, bodily injury, or even death.
- Children and adults should be alerted to the hazards of high surface temperatures and should stay away to avoid contact to skin and/or clothing.
- Young children should be carefully supervised when they are in the same room as the stove.
- Clothing and other flammable materials should not be placed on or near this unit.
- Flammable or explosive liquids such as gasoline, naphtha, alcohol, or engine oil must **NEVER** be used in or around stove. These liquids must be stored in a separate room as the open flame in the fire box could ignite the fumes of such liquids.
- **DO NOT** burn garbage in this unit. The burning of other solid fuels such as cord wood or wood chips in this stove is not permitted. Any fuels not certified which are burned in this stove will void the warranty.
- **DO NOT** route power cord in high traffic areas. A power surge protector plugged into a grounded 230 volt power source is required.
- **DO NOT** install a flue damper in the exhaust venting system of this unit.
- **DO NOT** connect this unit to a chimney flue servicing another appliance.
- **DO NOT** install in a sleeping room.
- **DO NOT** connect to any air distribution duct or system.
- **DO NOT** connect directly to a masonry chimney.
- **DO NOT** terminate vent in any enclosed or semi-enclosed area, such as; carports, garage, attic, crawl space, under a sun deck or porch, narrow walkway or closed area, or any location that can build up a concentration of fumes such as a stairwell, covered breezeway etc.
 - **NEVER** touch door latches while stove is in operation; they get extremely hot.

WARNING

PROPER INSTALLATION OF THIS STOVE IS NECESSARY FOR SAFE AND EFFICIENT OPERATION. INSTALLING THIS PRODUCT IMPROPERLY MAY RESULT IN A HOUSE FIRE AND PERSONAL INJURY.

ALL APPLICABLE BUILDING CODES FOR YOUR LOCATION MUST BE FOLLOWED. IN AREAS WHERE BUILDING CODES REQUIRE ADDITIONAL STEPS TO THE INSTALLATION OF THIS PRODUCT NOT INCLUDED IN THIS MANUAL, THE BUILDING CODES WILL TAKE PRECEDENT AND MUST BE FOLLOWED. CONTACT YOUR LOCAL BUILDING INSPECTOR TO OBTAIN ANY NECESSARY PERMITS OR INSPECTION GUIDELINES BEFORE INSTALLING THE PRODUCT.

This wood heater needs periodic inspection and repair for proper operation. It is against federal regulations to operate this wood heater in a manner inconsistent with operating instructions in this manual.

CAUTION

ALL APPLICABLE BUILDING CODES FOR YOUR LOCATION MUST BE FOLLOWED. IN AREAS WHERE BUILDING CODES REQUIRE ADDITIONAL STEPS TO THE INSTALLATION OF THIS PRODUCT NOT INCLUDED IN THIS MANUAL, THE BUILDING CODES WILL TAKE PRECEDENT AND MUST BE FOLLOWED. CONTACT YOUR LOCAL BUILDING INSPECTOR TO OBTAIN ANY NECESSARY PERMITS OR INSPECTION GUIDELINES BEFORE INSTALLING THE PRODUCT.

- Contact local building or fire officials about restrictions and installation inspection requirements in your area.
- Contact your local authority (such as municipal building department, fire department, fire prevention bureau, etc.) to determine the need for a permit.
- This pellet stove is designed to burn pellet fuel only.
- A working smoke detector is required and must be installed in the same room as the stove.
- This stove is not intended for use in commercial applications.
- Door and ash pan must be closed and latched during operation.
- Notify your insurance company of pellet stove installation.
- This installation must conform with local codes. In the absence of local codes you must comply with EN 14785.
- The structural integrity of the manufactured home floor, wall, and ceiling/roof must be maintained.
- Keep combustible materials (such as grass, leaves, etc.) at least three feet away from the flue outlet on the outside of the building.
- This stove should not be used as the only source of heat in the house. Power outages and periodic maintenance will result in a total loss of heat.
- Do not leave hopper door open while unattended.

CAUTION

INSTALLATION AND REPAIR OF THIS PELLET STOVE SHOULD BE DONE BY A QUALIFIED SERVICE PERSON. THE APPLIANCE SHOULD BE INSPECTED BEFORE USE AND AT LEAST ONCE A YEAR BY A QUALIFIED SERVICE PERSON. IT IS IMPERATIVE THAT THE CONTROL COMPARTMENTS, FIRE BOX, AND THE CIRCULATING AIR PASSAGEWAYS OF THE STOVE BE KEPT CLEAN.

THE OPERATION OF EXHAUST FANS SUCH AS BATH-ROOM FANS, ATTIC FANS, ETC. MIGHT STARVE THE PELLET STOVE OF COMBUSTIBLE AIR CREATING A NEGATIVE PRESSURE IN THE ROOM. PROVIDE ADEQUATE VENTILATION OF THE ROOM ACCOMPANYING THE PELLET STOVE. IF NOT, THE PRESSURE SWITCH MAY SHUT OFF OPERATION OF THE PELLET STOVE.

THE MOVING PARTS OF THIS STOVE ARE PROPELLED BY HIGH TORQUE ELECTRIC MOTORS. THESE PARTS CAN CAUSE SEVERE DAMAGE TO BODY PARTS THAT GET NEAR THEM. KEEP ALL BODY PARTS AWAY FROM AUGER AND FANS WHILE THE STOVE IS PLUGGED INTO AN

ELECTRICAL OUTLET. THESE MOVING PARTS MAY BEGIN TO MOVE AT ANY TIME THE STOVE IS PLUGGED IN. THE VENT SURFACES CAN GET HOT ENOUGH TO CAUSE BURNS IF TOUCHED. NONCOMBUSTIBLE SHIELDING OR GUARDS MAY BE REQUIRED.

INSTALL VENT AT CLEARANCES SPECIFIED BY THE VENT MANUFACTURER.

ALL VENTING JOINTS, WHETHER VERTICAL OR HORIZONTAL, SHOULD BE MADE GAS-TIGHT WITH RECOMMENDED SEALANTS SPECIFIED BY VENT MANUFACTURER.

ACCORDING TO HUD (HOUSING & URBAN DEVELOPMENT) REQUIREMENTS, WHEN INSTALLED IN A MOBILE HOME, THIS STOVE MUST BE GROUNDED DIRECTLY TO THE STEEL CHASSIS OF THE MOBILE HOME AND BOLTED TO THE FLOOR. DIRECT AIR ACCESS MUST BE PROVIDED, USE A FRESH AIR KIT.

FOR USE IN THE UNITED STATES AND CANADA.

APPROVED FOR INSTALLATION IN MOBILE HOMES.

PRODUCER OF THIS APPLIANCE, RESERVES THE RIGHT TO ALTER ITS PRODUCTS, SPECIFICATIONS AND/OR PRICE WITHOUT NOTICE.

TABLE OF CONTENTS

WARNINGS & SAFETY PRECAUTIONS	2-5
INTRODUCTION	7
Burning Pellet Fuel	7
Automatic Safety Features	8
SPECIFICATIONS	8
UNPACKING.....	8
INSTALLATION	9
Stove Placement	9
Floor Protection Requirements	9
Clearance to Combustibles	10
VENTING	11
Type of Vent.....	11
Pellet Vent Installation	11
Vent Termination Clearances	12-13
Outside Air Connection	14
Mobile Home	14
Venting Installation Examples	15-20
BECOMING FAMILIAR WITH YOU CONTROLLER	21-22
Controller Buttons	21
Screen Display	22
PRE-OPERATION	23
OPERATION	24
Start-up	24
Working in Different Operation Modes	24
Setting Data	25-29
Shutdown	29
MAINTENANCE	30-32
TROUBLESHOOTING & REPAIR	33
Troubleshooting Guide	34-35
Warranty	36

INTRODUCTION

Congratulations on your investment in quality. Thank you for your purchase on a comfortbilt stove from S.M.G, Inc. The HP55 comply with the ASTM E1509, (UM) 84-HUD, ULC/ORD-C-1482.

U.S. ENVIRONMENTAL PROTECTION AGENCY
Certified to comply with 2020 particulate emission standards using pellet fuel.

We have worked to ensure that this pellet stove meets the highest standards for usability and durability. With proper care, your stove will provide many years of dependable service. Please read entire manual before installation and use.

BURNING PELLET FUEL

Ashes need to be removed from the stove periodically. See Normal Care & Maintenance section for cleaning procedure. Due to the nature of pellet fuels, this stove will require attention periodically. Regular cleaning is an important part of burning pellet fuel.

PELLETS

- This pellet stove is designed and approved to burn wood pellets, that comply with pellet fuels industry standards. Minimum of 40 lbs. density per cubic feet, 1/4 to 5/16 in diameter, with a maximum length of 1-1/2, and less than 1% ash.

Pellet fuel quality can greatly fluctuate. The unit was tested with premium grade pellets. You cannot use a lesser grade, but higher grades can be used.

Do Not Burn:

1. Garbage;
2. Lawn clippings or yard waste;
3. Materials containing rubber, including tires;
3. Materials containing plastic;
4. Waste petroleum products, paints or paint thinners, or asphalt products;
5. Materials containing asbestos;
6. Construction or demolition debris;
7. Railroad ties or pressure-treated wood;
8. Manure or animal remains;
9. Paper products, cardboard, plywood, or particleboard. The prohibition against burning these materials does not prohibit the use of fire starters made from paper, cardboard, saw dust, wax and similar substances for the purpose of starting a fire in an affected wood heater.

Burning these materials may result in release of toxic fumes or render the heater ineffective and cause smoke.

- The performance of your pellet stove is greatly affected by the type and quality of wood pellets. As the heat output of various quality wood pellets differ, so will the performance and heat output of the pellet stove.
- Wood pellets are generally produced out of wood waste such as sawdust and shavings. The raw material is dried, mechanically fractioned to size and extruded into pellets under high pressure. Wood pellets need to be protected from direct exposure to water. Water from sources such as condensation and humidity causes pellets to expand and break down into unusable fuel. Keep fuel dry.
- It is important to select and use only pellets that are dry and free from dirt and debris. Dirty fuel will adversely affect the operation and performance of the unit and will void the warranty. The Pellet Fuel Institute (PFI) has established standards for wood pellet manufacturers. Only use pellets that meet or exceed PFI standards for premium fuels.

CLINKERS

- Impurities, such as silica (clinkers), will need to be regularly cleaned and removed from the pellet stove. Clinkers will form a hard mass and block airflow through the pot liner. High quality fuels will result in fewer clinkers



WARNING

IF THE ELECTRICAL POWER FAILS ANY TIME WHEN THE STOVE IS HOT, KEEP ALL STOVE DOORS CLOSED. THE AUTOMATIC SAFETY FEATURES MUST NOT BE BYPASSED.



WARNING

BURNING WOOD PELLETS ACCORDING TO RECOMMENDATIONS WILL ASSURE LONGER STOVE LIFE AND LESS FUEL RELATED PROBLEMS.

THE USE OF GRATES OR OTHER METHODS OF SUPPORTING THE FUEL IN THIS STOVE IS PROHIBITED AND WILL VOID ALL WARRANTIES

AUTOMATIC SAFETY FEATURES

POWER OUTAGE

During a power outage, the stove will shut down safely. Do not open the main door or ash door. During a power failure the exhaust fan will not run. Keeping the doors sealed will allow the exhaust vent to draft out naturally. When the power is restored, the stove will not restart. If the exhaust temperature is still 120 degrees Fahrenheit when power is restored, the exhaust and convection fans will continue to run until the stove cools. See lighting instructions to restart stove.

Install at least one smoke detector on each floor of your home to ensure your safety. They should be located away from the heating appliance and close to the sleeping areas. You should have another CO monitors for areas near the stove.

OVERHEATING

Over Fire Protection: If the stove is being over fired or burning too hot, the high limit switches will automatically shut down the stove to avoid damage to components. If the temperature on the hopper reaches 200 degree Fahrenheit, the auger will automatically stop and the stove will shut down. The exhaust fan will continue to run until the proof of fire switch cools. Allow stove to cool before attempting to re-ignite. See lighting instructions



WARNING

If the unit is modified, it will not be compliant with EPA regulations.



WARNING

If you can see "black smoke" at the end of the chimney, the emission maybe have been abnormal.

You should check :

- 1) If there is an serious clinker in the burnpot.
- 2) If there are some leakages on the stove for example the glass door
- 3) The exhaust channel have been blocked partially.

The input voltage is abnormal

SPECIFICATIONS

Model Number	HP55
BTU/hour output (1)	15.425Btu/hr~37.000 Btu/hr(2)
Heating Capacity (3)	Up to 2,200 sq.ft
Electrical Rating	115 Volts, 60Hz
Efficiency	81.4%
CO Emissions (g/hr) (4)	3.8(min)~19.5(max)
Particulate Emissions	1.2 g/hr
Power Consumption	525 Watts ignition 75 Watts operating
Fuel Storage Capacity	50 lbs
Flue Size	75mm (3")
Width	495mm (19 1/2")
Height	930mm (36 3/4")
Depth	621mm (24 1/2")
Weight	77kg (170lbs)

(1)Heat output will vary, depending on the brand, type and quality of fuel and the moisture content. Consult your dealer for best results.

(2) This wood heater has a manufacturer-set minimum low burn rate that must not be altered. It is against federal regulations to alter this setting or otherwise operate this wood heater in a manner inconsistent with operating instructions in this manual."

(3) Based on post 1982 home construction, requiring 35 BTU/ Hr. per Sq. Ft.

(4) CO Emissions will vary, depending on the feed level, burning time and fuel. Consult your dealer for best results.

GLASS SPECIFICATIONS

This stove is equipped with ceramic glass. Replace glass only with Qualified ceramic glass.

UNPACKING

Your stove will come fully assembled. Remove all packing material and tape from the inside of the firebox. Remove any tape on the outside of the glass. Open the hopper, remove all packing material and power cord.

NOTE: MAKE SURE THE HOPPER IS FREE OF ALL FOREIGN MATTER BEFORE FILLING WITH FUEL. FOREIGN MATERIAL WILL CAUSE AUGER JAMS AND WILL VOID STOVE WARRANTY.

INSTALLATION

It is recommended the stove be installed and serviced by authorized professionals.

Proper installation of this stove is necessary for safe and efficient operation. Installing this product improperly may result in a house fire and personal injury. All applicable building codes for your location must be followed. In areas where building codes require additional steps to the installation of this product not included in this manual, the building codes will take precedent and must be followed. Contact your local building inspector to obtain any necessary permits or inspection guidelines before installing the product.

STOVE PLACEMENT

Sketch out a plan for installing the stove including dimensions before permanent placement. When determining the location for the stove, wall stud location is critical. You may need to adjust the location of the stove to avoid trying to vent through a wall stud. Before placing the pellet stove, connect the vent and allow for minimum clearance to combustible walls.

FLOOR PROTECTION REQUIREMENTS

The stove must be installed on a noncombustible floor, with proper floor protection, or on a masonry hearth. When a clean out t-vent is installed in the inside of a home, the floor protector must extend 2 beyond rear of t-vent. **SEE FIGURE 1.**

When stove

SEE FIGURE 1 When stove is vented straight through the wall and the clean out t-vent is on the exterior of the home, the minimum clearance is 2 from the back of the stove to the wall. **SEE FIGURE 2.** The minimum floor protector material is 24 GA sheet metal

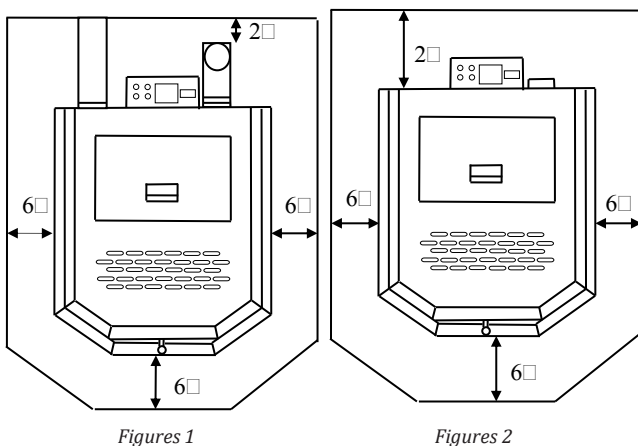

Figures 1 and 2: Pellet stove floor pad clearances



WARNING

READ THIS ENTIRE MANUAL BEFORE YOU INSTALL AND USE THIS STOVE. FAILURE TO FOLLOW THE INSTRUCTIONS MAY RESULT IN PROPERTY DAMAGE, BODILY INJURY, OR EVEN DEATH.

DO NOT INSTALL A FLUE DAMPER IN THE EXHAUST VENTING SYSTEM OF THIS UNIT.

DO NOT CONNECT THIS UNIT TO A CHIMNEY FLUE SERVING ANOTHER APPLIANCE.

CHILDREN AND ADULTS SHOULD BE ALERTED TO THE HAZARDS OF HIGH SURFACE TEMPERATURES AND SHOULD STAY AWAY TO AVOID BUMPS TO SKIN AND/OR CLOTHING.

YOUNG CHILDREN SHOULD BE CAREFULLY SUPERVISED WHEN THEY ARE IN THE SAME ROOM AS THE STOVE.

CLOTHING AND OTHER FLAMMABLE MATERIALS SHOULD NOT BE PLACED ON OR NEAR THIS UNIT.



CAUTION

THIS STOVE SHOULD NOT BE USED AS THE ONLY SOURCE OF HEAT IN THE HOUSE. POWER OUTAGES AND PERIODIC MAINTENANCE WILL RESULT IN A TOTAL LOSS OF HEAT.

CONTACT LOCAL BUILDING OR FIRE OFFICIALS ABOUT RESTRICTIONS AND INSTALLATION INSPECTION REQUIREMENTS IN YOUR AREA.

CONTACT YOUR LOCAL AUTHORITY (SUCH AS MUNICIPAL BUILDING DEPARTMENT, FIRE DEPARTMENT, FIRE PREVENTION BUREAU, ETC.) TO DETERMINE THE NEED FOR A PERMIT.

KEEP COMBUSTIBLE MATERIALS (SUCH AS GRASS, LEAVES, ETC.) AT LEAST 3 FEET AWAY FROM THE FLUE OUTLET ON THE OUTSIDE OF THE BUILDING.

INSTALLATION AND REPAIR OF THIS

PELLETSTOVE SHOULD BE DONE BY A QUALIFIED SERVICE PERSON. THE APPLIANCE SHOULD BE INSPECTED BEFORE USE AND AT LEAST ANNUALLY BY A QUALIFIED SERVICE PERSON. IT IS IMPERATIVE THAT CONTROL COMPARTMENTS, FIRE BOX, AND CIRCULATING AIR PASSAGEWAYS OF THE STOVE BE KEPT CLEAN.

CLEARANCES TO COMBUSTIBLES

NOTE: These are minimum clearances to combustible walls.

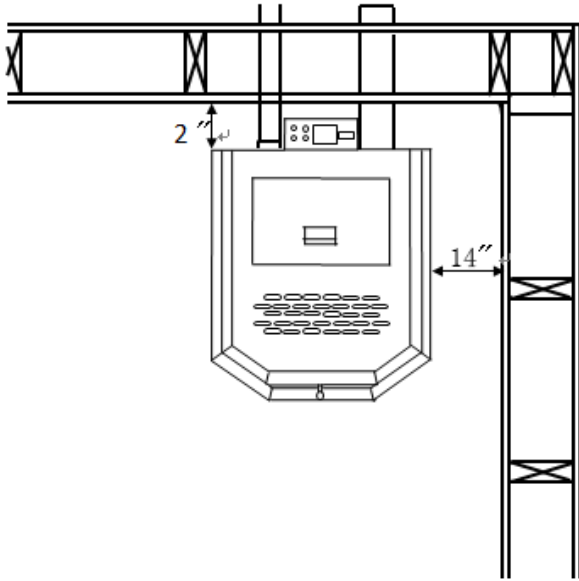

Figure 3: Straight installation through wall

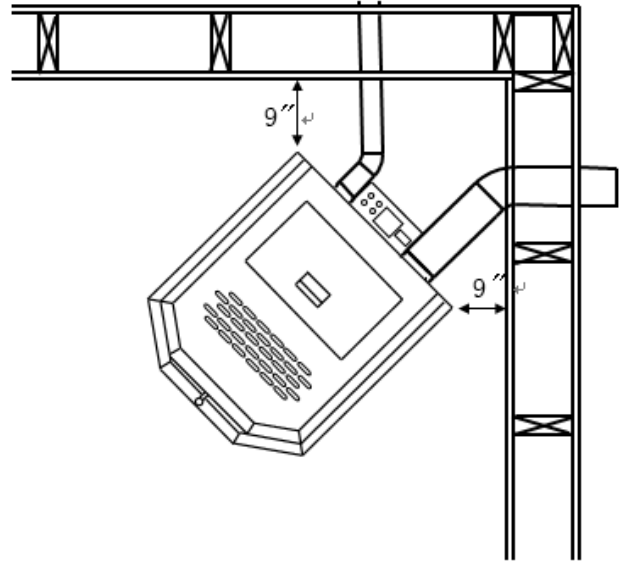

Figure 4: Corner installation through the wall vents

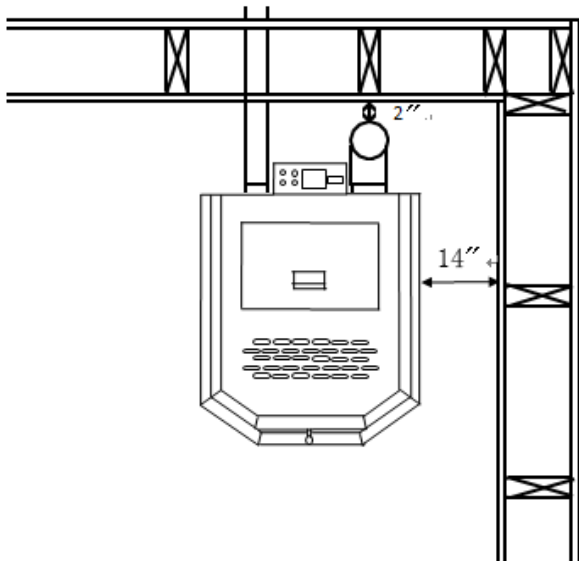

Figure 5: Straight installation interior vertical vents

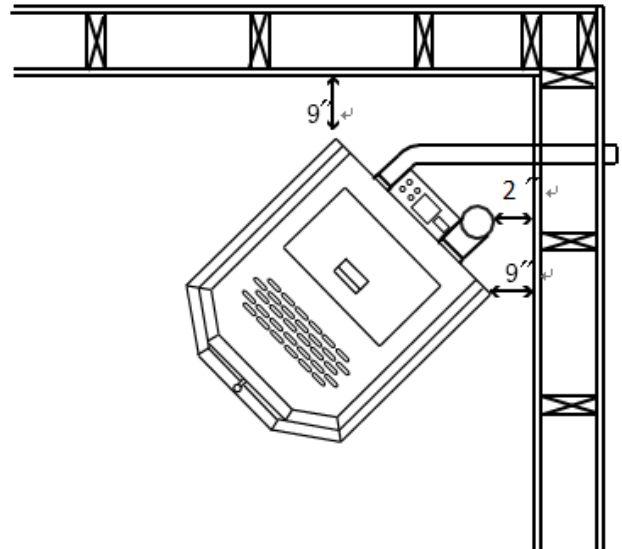

Figure 6: Corner installation interior vertical vents

NOTE: When interior vent is installed vertically, the clearance to the back wall is determined by the vent size used. Install vent at clearance specified by the vent manufacturer. Take into consideration any upward turning elbows or tees.

VENTING

Before venting, consult vent manufacturer's specifications and recommendations for all venting installations.

The following installation guidelines must be followed to ensure conformity with both the safety listing of this stove and to local building codes.

TYPE OF VENT

The pellet venting pipe (also known as L vent) is constructed of two layers with air space between the layers. This air space acts as an insulator and reduces outside surface temperature of pipe to allow a clearance to combustibles. A cap must be used at the termination of type L vent chimneys. For elevations above 5,000 feet above sea level, a 4" L is required.

PELLET VENT INSTALLATION

Vent termination **MUST** exhaust above air inlet elevation. It is recommended to install at least three feet (3') of vertical pellet vent pipe. This vertical pipe will create some natural draft to prevent the possibility of smoke or odor during appliance shutdown and will keep exhaust from causing a nuisance or hazard from exposure to high temperatures.

The installation must include a clean out tee to enable collection of fly ash and to permit periodic cleaning of the exhaust system. Total length of horizontal vent must not exceed 10 feet. The maximum recommended vertical venting height is 18 feet.

All joints for pellet vent are required to be fastened with at least three screws and all pellet vent connections (including adapters, elbows, etc.) should be sealed airtight by injecting 500 F. RTV silicone into the gap between sections.

The area where the vent pipe goes through to the exterior of the home must be sealed with silicone or other means to maintain the vapor barrier between the exterior and the interior of the home.

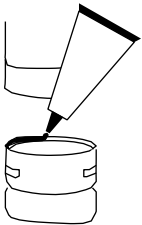

WARNING

DO NOT CONNECT THIS UNIT TO A CHIMNEY FLUE SERVING ANOTHER APPLIANCE.

DO NOT INSTALL A FLUE DAMPER IN THE EXHAUST VENTING SYSTEM OF THIS UNIT.

DO NOT CONNECT DIRECTLY TO A MASONRY CHIMNEY.

DO NOT TERMINATE VENT IN ANY ENCLOSED OR SEMI-ENCLOSED AREA, SUCH AS; CARPORTS, GARAGE, ATTIC, CRAWL SPACE, UNDER A SUN DECK OR PORCH, NARROW WALKWAY OR CLOSED AREA, OR ANY LOCATION THAT CAN BUILD UP A CONCENTRATION OF FUMES SUCH AS A STAIRWELL, COVERED BREEZEWAY ETC



CAUTION

VENT SURFACES CAN GET HOT ENOUGH TO CAUSE BURNS IF TOUCHED. NONCOMBUSTIBLE SHIELDING OR GUARDS MAY BE REQUIRED.

PELLET VENT MUST MAINTAIN MINIMUM CLEARANCES SPECIFIED BY VENT MANUFACTURER FOR CLEARANCE TO ANY COMBUSTIBLES.

INSTALL VENT AT CLEARANCES SPECIFIED BY THE VENT MANUFACTURER.

ALL VENTING, WHETHER VERTICAL OR HORIZONTAL, JOINTS SHOULD BE MADE GAS-TIGHT WITH RECOMMENDED SEALANTS.

PREFERRED PELLETT VENT TERMINATION CLEARANCE

- The stove vent must terminate on the outside of the building. Horizontal terminations must extend a minimum of 12" from the wall. Vertical terminations must protrude a minimum 24" from the roof surface. In addition, all clearances listed below must be met. **SEE FIGURE 7**
- Must have an approved cap (to prevent water from entering) or a 45° downturn with rodent screen.
- If the termination is located on a windy side of the house, we suggest using an approved house shield to prevent soot from building up on the side of the house.
- A vent must not be located where it will become plugged by snow or other material

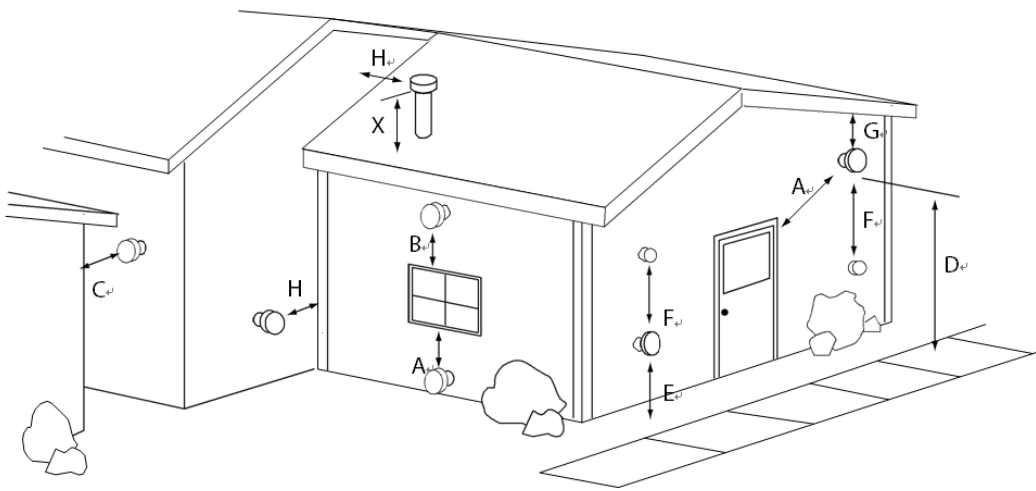

Figure 7: Vent Termination

- A: A Minimum 4' clearance below or beside any door or window that opens. (This clearance may be reduced to 18" if using out-side air). We recommend the door or window be kept closed during operation. Minimum 1' clearance below or beside any window that does not open.
- B: Minimum 1' clearance above any door or window that opens
- C: Minimum 2' clearance from any adjacent building
- D: Minimum 7' clearance above any grade when adjacent to public walkways
- E: Minimum 2' clearance above any grass, plants, or other combustible materials.
- F: Minimum 3' clearance from any forced air intake of any other appliance
- G: Minimum 2' clearance below eaves or overhangs
- H: Minimum 1' clearance horizontally from combustible wall
- X: Must be a minimum of 2' above the roof

NOTE: Vent may not terminate in covered walkway or breeze- way.

Venting the Pellet Stove:

- Do not install flue damper in the exhaust venting system of this unit
- Use an approved wall thimble when passing the vent through walls. Use a ceiling support/fire stop spacer when passing the vent through ceilings (make sure to maintain clearance to any combustibles.)
- if using more than one tee and 180° of elbows, you must use 4 " venting pipes.

NOTE: In order to achieve optimum performance, it is recommended that you keep the vent as short as possible, especially in regards to the horizontal run. The vent must have a support bracket every 5 'of pellet vent when on the exterior of the structure. The vent height and run must not exceed the distance as illustrated in the diagram below. Venting into this(the lighter)shaded area any require combustion motor voltage adjustments and/or inlet air adjustments(intake). SEE FIGURE 9.

INTAKE & EXHAUST POSITIONS

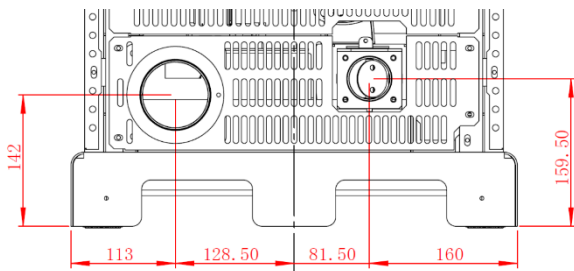

Figure 8: Intake and exhaust positions

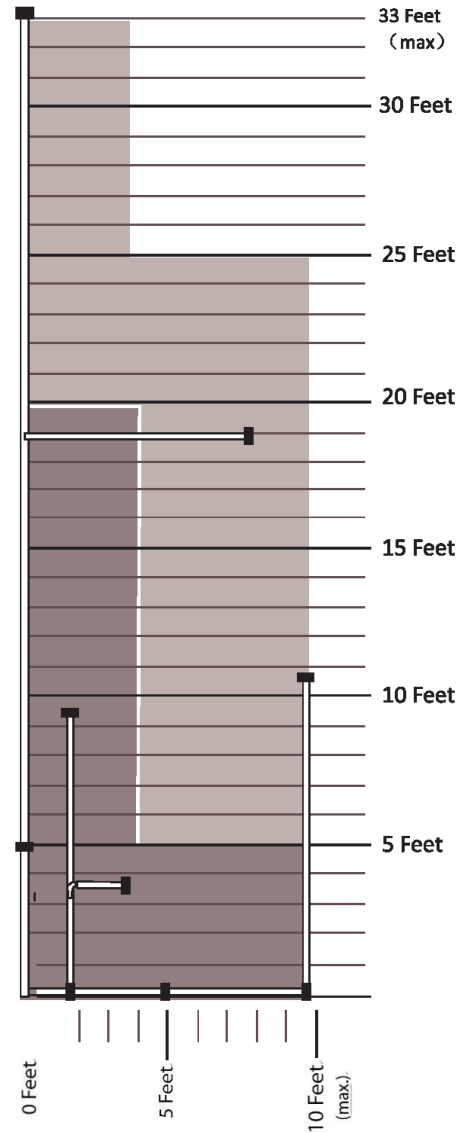

Figure 9: Venting and combustion motor voltage adjustment chart

OUTSIDE AIR CONNECTION

The efficiency of ComfortBilt pellet stoves can be impacted by the temperature of the air supplied to the burn pot, and the temperature of the air that is drawn past the heat exchanger to heat the room. When exterior air supplied to the burn pot is extremely cold, slightly more energy is needed to burn pellets at optimum temperatures. A disadvantage of supplying interior room air to the burn pot is that the room air used by the burn pot (and sent out the exhaust pipe) must be replaced by air drawn in through windows, doors and cracks. Using interior air is not recommended in newer houses that are tightly sealed. Air drawn in by the heat exchanger is always interior room air and should be the coolest air in the living space. Stoves therefore work best when they are placed at the lowest level of a home, and located so that all the air in the room is freely available to the stove's heat exchanger.

Connection from the intake pipe (2" diameter pipe in rear of stove) to the outside of the house is REQUIRED for mobile home installation. It is recommended in tightly sealed homes with exhaust fans such as kitchen or bathroom fans. This will eliminate poor performance due to negative pressure.

Only noncombustible pipe 2" (or greater) in diameter is approved to use for outside air connections (straight or flexible). PVC pipe is NOT approved and should NEVER be connected to the stove.

If the air inlet is connected to the outside, it MUST be terminated with a vertical 90° bend (down) or with a wind hood. Failure to do so could result in a burn back during high winds blowing directly up the air inlet during a simultaneous power failure.

Blockage, excessive length, or extra bends in the air intake pipe will starve the stove of combustion air. A 90° bend is equivalent in restriction to approximately 30" of straight inlet pipe.

MOBILE HOME

Installation in a mobile home should be in accordance with the manufactured home and safety standard (HUD), CFR 3280, Part 24. This stove must be vented to the outside. In addition to the standard installation instructions, the following requirements are mandatory for installation in a mobile home:

1. The stove must be permanently attached to the floor.
2. Stove must have an outside air source.
3. Stove must be electrically grounded to the steel chassis of the mobile home.
4. All vertical chimney vents must have wall supports.
5. All exhaust systems must have a spark arrestor.
6. Check with local building officials to see if other codes may apply.



WARNING

DO NOT CONNECT TO ANY AIR DISTRIBUTION DUCT OR SYSTEM.
DO NOT INSTALL IN A SLEEPING ROOM.



CAUTION

THE OPERATION OF EXHAUST FANS SUCH AS BATHROOM FANS, ATTIC FANS, ETC. MIGHT STARVE THE PELLET STOVE OF COMBUSTIBLE AIR CREATING A NEGATIVE PRESSURE IN THE ROOM. PROVIDE ADEQUATE VENTILATION IN THE ROOM ACCOMPANYING THE PELLET STOVE. IF NOT, THE PRESSURE SWITCH MAY SHUT OFF OPERATION OF THE PELLET STOVE. THE STRUCTURAL INTEGRITY OF THE MANUFACTURED HOME FLOOR, WALL, AND CEILING/ROOF MUST BE MAINTAINED

UNDERSTANDING YOUR STOVE

Your Stove utilizes a vertical auger fuel feed system that is operated by a microprocessor controlled digital circuit board. The digital circuit board allows the vertical auger fuel system to run in a timer based, non-continuous cycle; this cycling allows the auger to run for a predetermined amount of time. The auger pushes pellets up a chute located in the hopper. The pellets will then turn and fall through another chute into the burn pot. Your stove is equipped with an automatic ignition system that should ignite the fuel within 3-5 minutes of pressing the On/O button. As pellets fill the burnpot and ignite, outside air is drawn across the fuel and heated during the combustion process which is then pulled across the heat exchanger by the exhaust motor or the draft fan. As the stove reaches operating temperature, room air is then circulated around the heat exchanger by a room air blower, distributing warm air into the room. The amount of heat that is produced by the stove is proportional to the rate of fuel that is burned. Because a forced draft pressure is required for the combustion process inside your stove, it is extremely important that the exhaust system be properly installed and maintained. Also, the doors must remain closed while in operations and the seals on the doors must be properly maintained

Operator's Manual
HP55 Pellet Stove
SIMPLE STOVE VENTILATION EXAMPLES

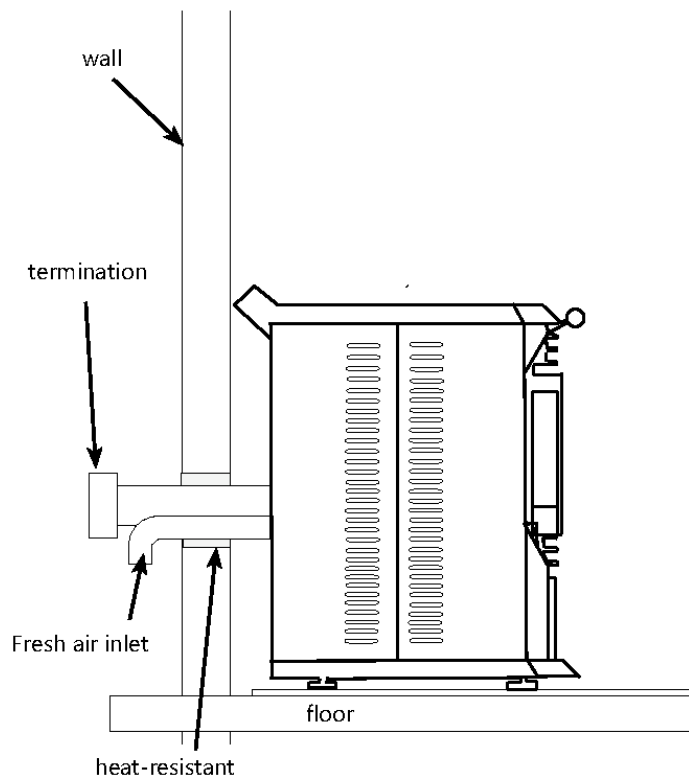

Figure 10: Straight Installation--outside, through wall installation

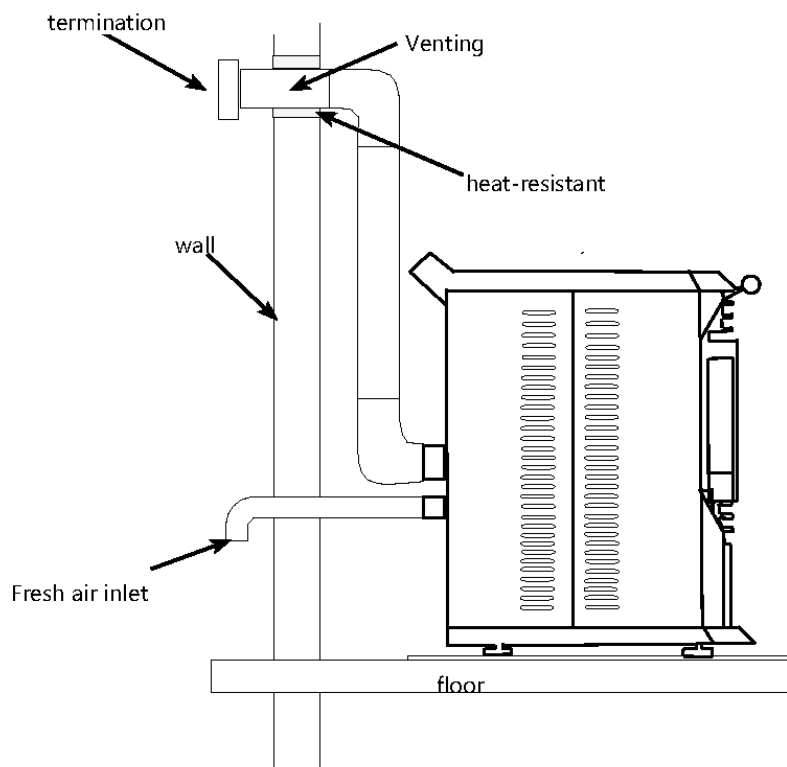
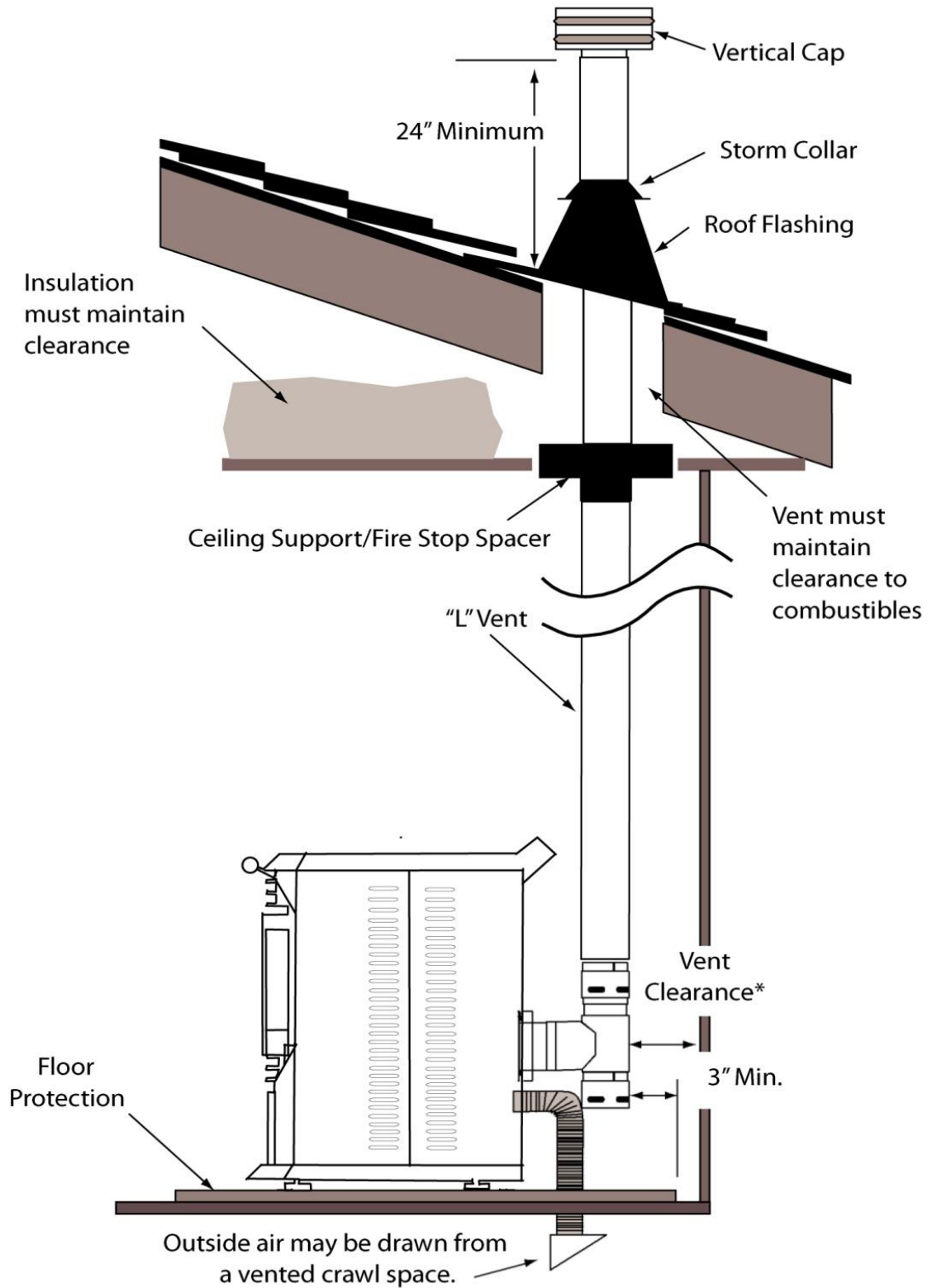

Figure 11: Straight Installation—inside vertical rise, horizontal termination

Operator's Manual
HP55 Pellet Stove
COMPLEX STOVE VENTILATION EXAMPLES
INTERIOR VERTICAL INSTALLATION



* Install a vent at clearance specified by the vent manufacturer

Figure 12: Interior Vertical Installation

Operator's Manual
HP55 Pellet Stove
CLASS A CHIMNEY RETROFIT

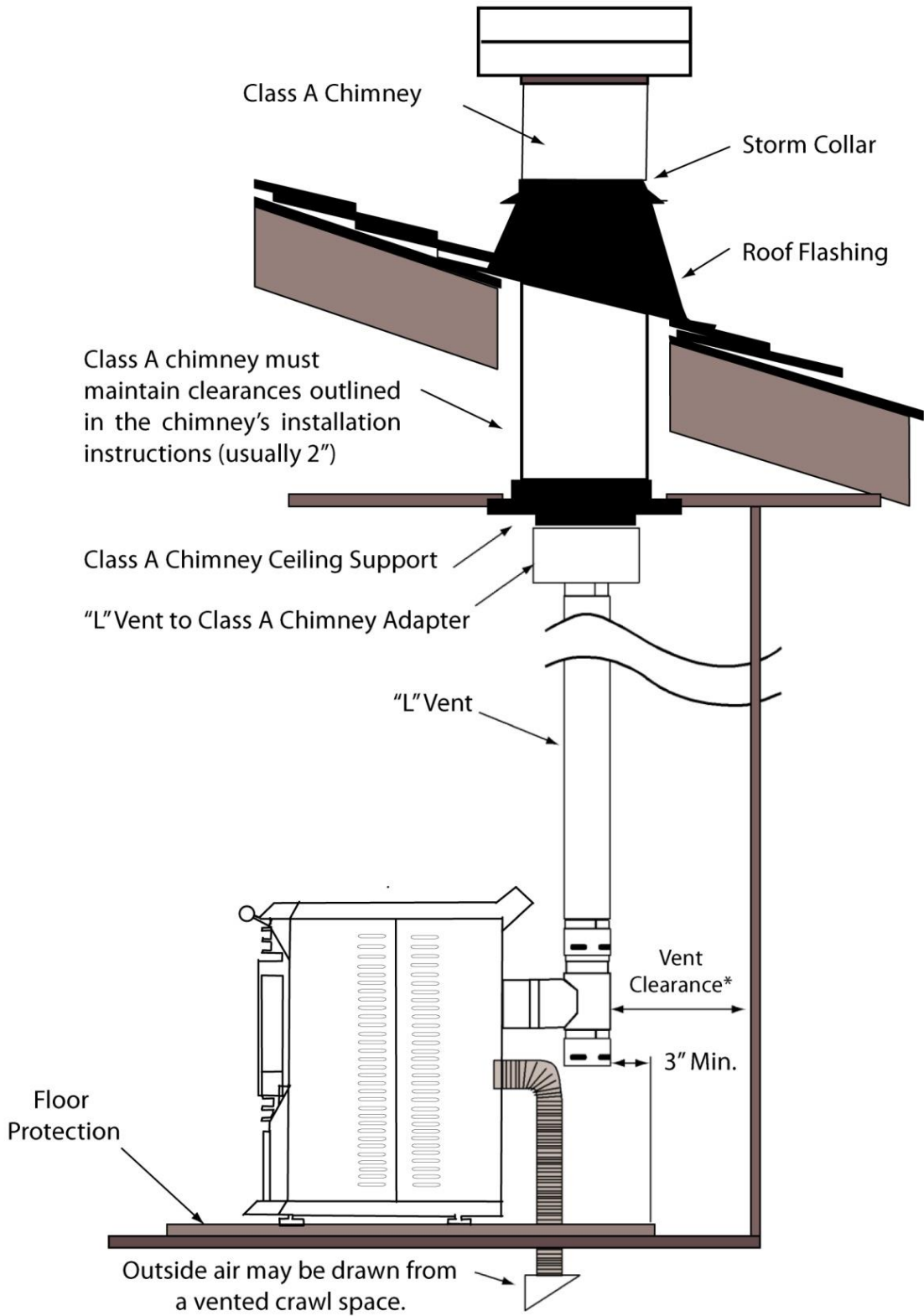

* Install a vent at clearance specified by the vent manufacturer

Figure 13: Class A Chimney Retrofit

MASONRY FIREPLACE HEARTH STOVE

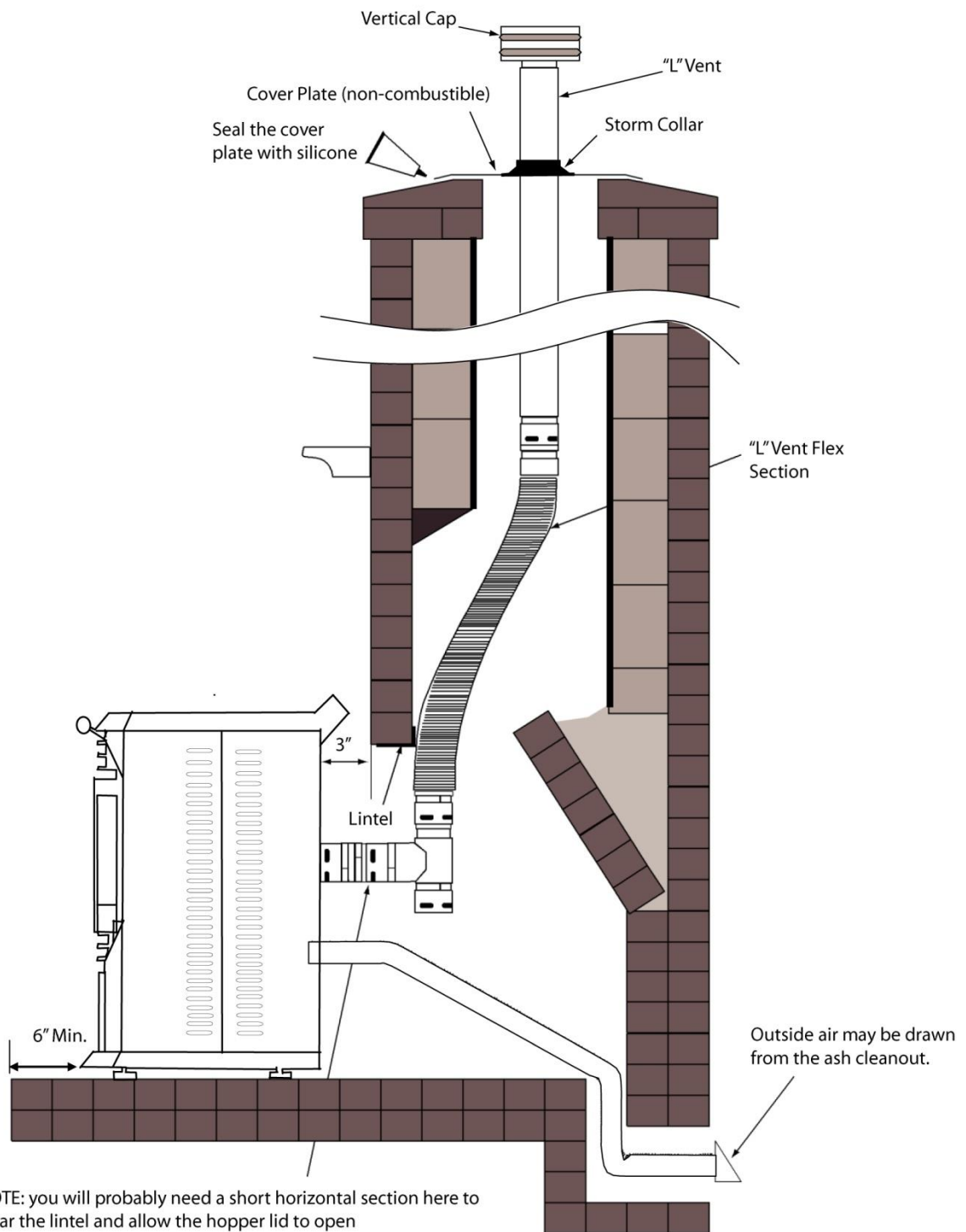
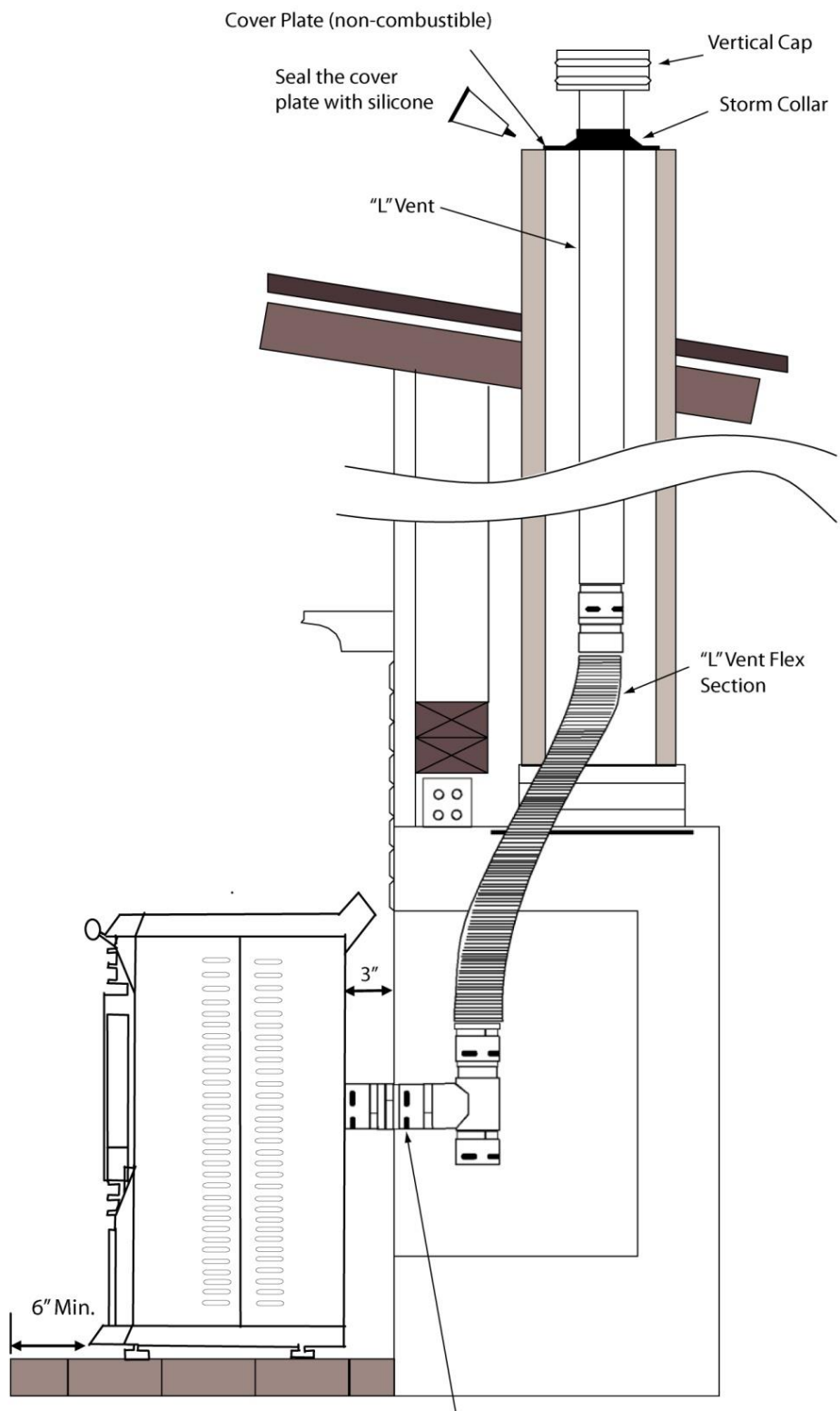

Figure 14: Masonry Fireplace Hearth Stove

Operator's Manual
HP55 Pellet Stove
ZERO-CLEARANCE (METAL) FIREPLACE HEARTH
STOVE



NOTE: you will probably need a short horizontal section here to clear the lintel and allow the hopper lid to open.

Figure 15: Zero-Clearance (Metal) Fireplace Hearth Stove

FREESTANDING MASONRY CHIMNEY

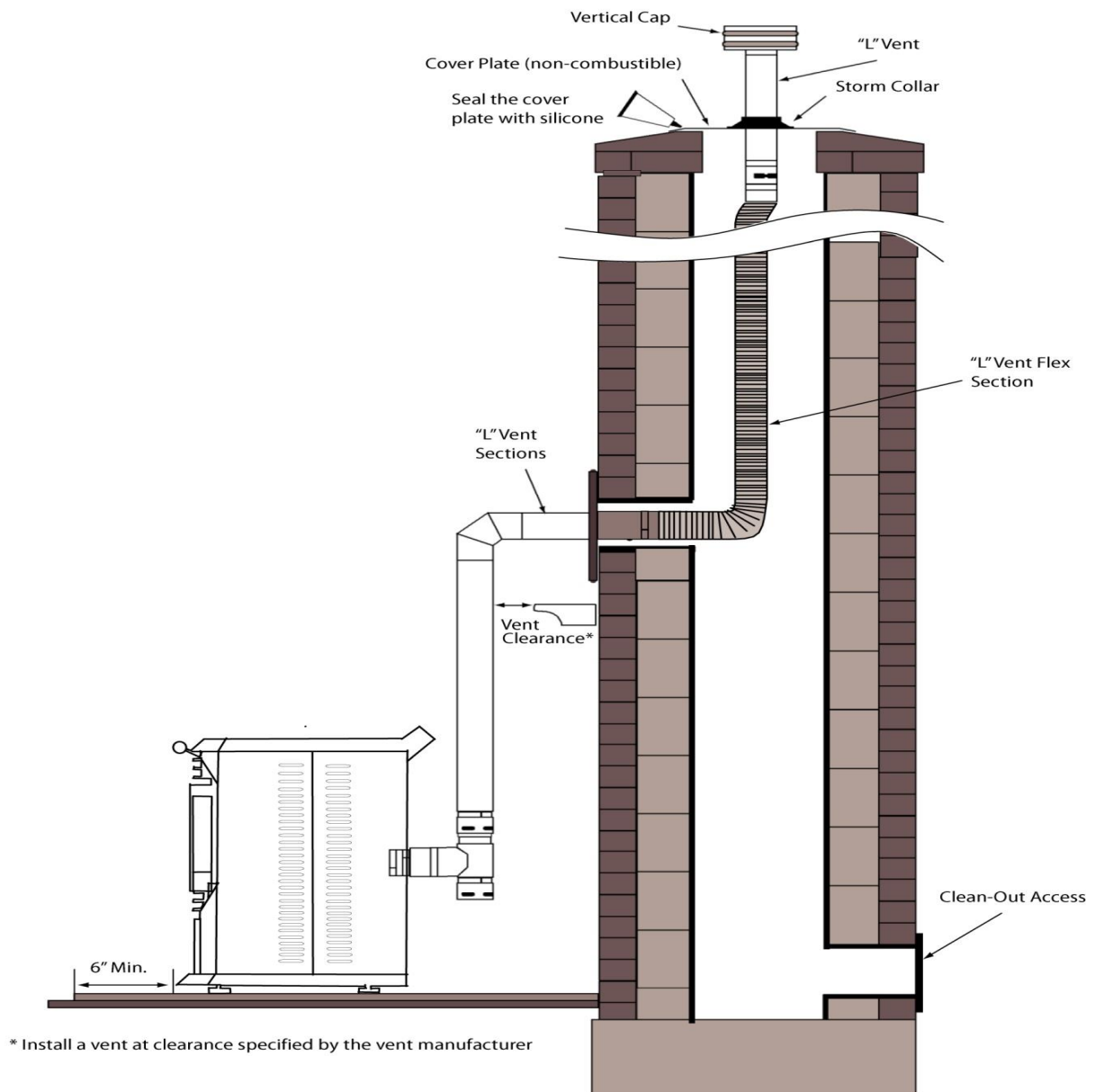

Figure 16: Freestanding Masonry Chimney

BECOMING FAMILIAR WITH YOUR CONTROLLER

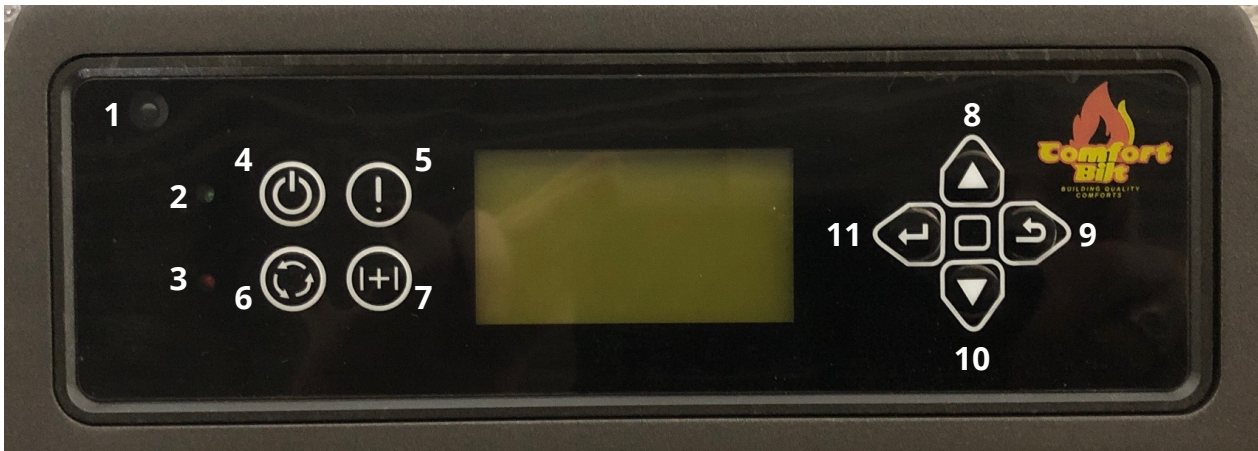

Figure 17: Control pad key

CONTROLLER BUTTONS

- 1) **Infrared Receiver:** Receives signal from remote control. (Available separately)
- 2) **Power Indicator:** Illuminates when main power is switched on.
- 3) **Alarm Light:** Illuminates if stove is not operating correctly.
- 4) **On/Off Button:** Starts and stops operation of stove.
- 5) **Information Button** (may look like clock-face): Allows you to read the real-time status of the stove at any time.
- 6) **Mode Transfer Button:** Allows you to set the unit to one of four main mode settings: Manual, Temp, Weekly, and Thermostat.
- 7) **Combination Function Button** (may look like lock): After you press this key, the "Key Combination" indicator will light. You can then press another key to complete an operation. See the combination key function list below:
 - Key 6:** Timer (use scroll up and down to change value)
 - Key 11:** Feeding (Used for newly installed stoves to prime the auger)
 - Key 9:** Stop Feeding
 - Key 4:** Child Lock (Hold Key 4 for 3 seconds to activate child lock. Hold Key 9 for 3 seconds to disengage child lock)
- 8) **Scroll up Button:** Allows you to scroll up to choose items in the menu.
- 9) **Exit Button:** Take you out of current selection and returns to previous option and/or screen. When entering data, pressing the EXIT button will delete your entries.
- 10) **Scroll Down Button:** Allows you to scroll down to choose items in the menu.
- 11) **Enter Button:** Pressing "Enter" button allows you to adjust and select data on the screen. Pressing the "Enter" button for 3 seconds will take you to a main menu screen in which you will have the ability to change the time, date, temperature display, weekly operation schedule (for Weekly Mode only) and combustion settings

Operator's Manual
HP54 Pellet Stove
MAIN OPERATION CONTROLLER SCREEN
DISPLAY

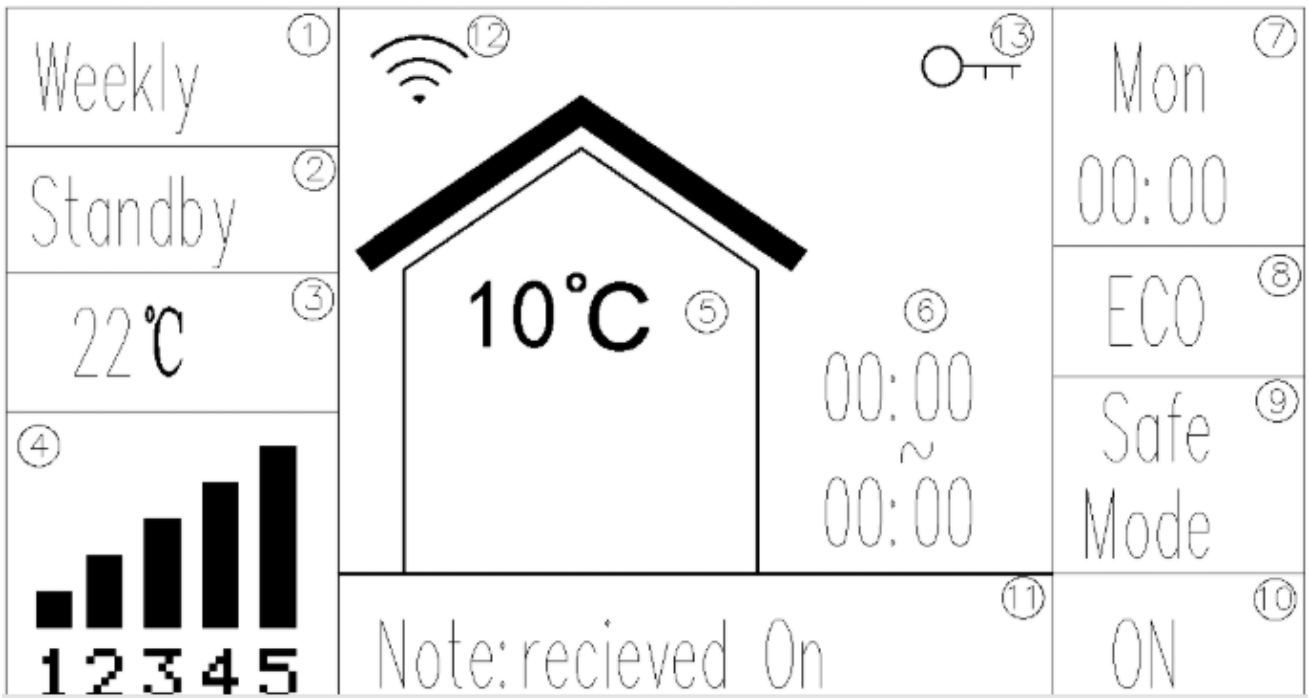

Figure 18: Display Screen

- 1) Mode:** Displays operation mode (Manual, Temp, Weekly, or Thermostat).
- 2) Work Stage:** Displays the operational stage the stove is currently in (i.e. Ignite, Heating, Fire Off, Standby, Stop, etc...)
- 3) Desired Temperature:** In Temp or Weekly mode, this will show the currently set temperature.
- 4) Heat Power Level:** Displays the current set Heat level. (In Manual mode, you can directly set this. In other modes, this will change based on other requirements set by the stove)
- 5) Current Temperature:** Displays the temperature that is being read by the temp-sensing wire.

- 6) Current Time Period:** In weekly mode, this displays the current time setting.
- 7) Day and Time:** Displays the day of the week and current time.
- 8) ECO Mode Indicator:** Displays the current status of the ECO settings (on of off)
- 9) Safe Mode Indicator:** If the vacuum or limit switches are being bypassed, the stove will operate in "Safe Mode".
- 10) On/Off Indicator:** Indicates if the stove is on and in operation or in the process of shutting down.
- 11) Information Bar:** Displays real-time messages such as operations by App.
- 13) Child Lock Indicator:** Indicates when child lock is currently active.

*12) wifi mode is currently not used

PRE-OPERATION

Once the stove has been properly installed and plugged into a grounded surge protector you are ready to begin operation.

MOUNTING YOUR CONTROLLER

Mount the controller and the controller bracket to top and back of your stove using the supplied hardware, and then attach the data cable on the backside into the controller.

SEE FIGURE 19

PRIOR TO STARTING

Turn on the main power switch located on the back of the stove. SEE FIGURE 20A

NOTE: IF FOR SOME REASON THE STOVE DOES NOT APPEAR TO BE POWERING ON, THERE IS A FUSE LOCATED JUST BELOW THE POWER SWITCH THAT CAN BE CHECKED. SEE FIGURE 20B. NOTE THAT THERE IS A SPARE FUSE LOCATED IN THE FUSE HOLDER.

Make sure the hopper is clean and free of foreign matter including pellet fines and dust. Fill the hopper with wood pellets, making sure that NO parts of the bag or any foreign objects enter the hopper as this may cause harm to the auger feed system. SEE FIGURE 21.

Also take care in making sure there is no pellet material in the hopper lid seating surfaces.

Close the lid. This stove has a safety switch that will not allow pellets to feed with the hopper door open.

Make sure the main glass door is closed. The stove has a safety switch that will not allow the stove to feed fuel unless there is negative draft pressure inside the stove.

Before actually starting your Stove, you will need to determine in which mode you would like to run the stove. This stove can operate in four modes:

1.Manual: Under this mode, you can personally adjust and set the heating phase to control the heat level.

2.Temp: Under this mode, you can set the room temperature and the stove will automatically run to ensure the room is at that temperature.

3.Weekly: Under this mode, the stove will work automatically during days and times you designate. You can have a program for each of the seven days of the week and four periods during the day

4.Thermostat: Only valid for the system equipped with the extra thermostat.

You must select your mode before turning on the stove.

Selecting a mode while the stove is burning may cause the stove to shut down and may force a 30-minute delay in restarting. You do not need to start operation of the stove to select your mode. To choose the mode, select the mode

transfer button  . Pressing the mode button once selects the temp setting; selecting it twice will bring you to the weekly mode; Selecting it three times will bring you to the thermostat mode.

WARNING:

NEVER USE FLAMMABLE LIQUIDS SUCH AS GASOLINE, GASOLINE TYPE LIGHTER FUEL, CHARCOAL LIGHTER FUEL OR FIRE STARTING GELS IN OR AROUND THIS STOVE. KEEP ALL SUCH LIQUIDS WELL AWAY FROM THE STOVE WHEN IT IS IN USE.

NEVER OPEN SIDE PANELS OR MAIN DOOR WHEN STOVE IS IN OPERATION.

NEVER TOUCH DOOR LATCHES WHILE IN OPERATION, THEY GET EXTREMELY HOT.

NEVER OPEN GLASS DOOR WHILE STOVE IS OPERATING OR WHILE STOVE IS HOT.

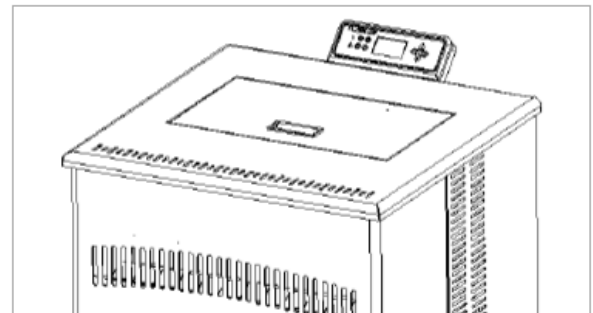

Figure 19: Control pad location

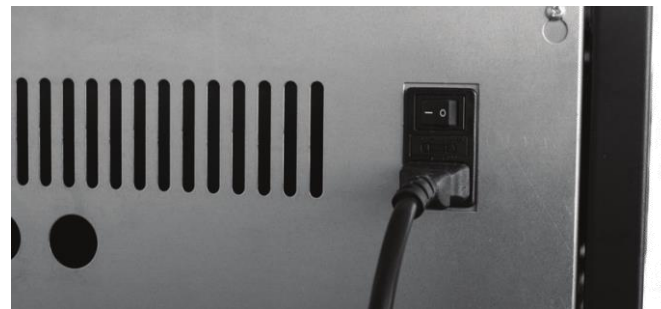

Figure 20a: Main power switch



Figure 20b: Main power switch



Figure 21: Pellet load

OPERATION

After you have chosen the mode in which to operate your stove, press the ON/OFF button  to start the stove ignite cycle

START UP



When the stove turns on, the on/off state indicator change to on, and "Ignite" will also appear on the screen (2 in Figure 19). The pellets start to fall into burn pot. Within three to five minutes of the auger feeding pellets, a fire should ignite. Once a fire is lit, the work stage box on the screen will read "Heating" (2 in Figure 19).

WORKING IN THE DIFFERENT OPERATION MODES

MANUAL MODE

The Manual Mode is the default mode setting if no other mode is chosen before the stove is turned on. In the manual mode, you have the ability to change the heat levels, which will increase or decrease the amount of heat that the stove puts out.

To change the power level in manual mode, use the

SCROLL DOWN or SCROLL UP buttons   on the control pad. (See buttons 8 and 10 on Figure 17.) Pressing either of these buttons once will move the power level up or down one level. The power level is showed at the location of 4 on Figure 19

NOTE: This mode does not allow you to directly adjust specific temperatures. The manual mode simply allows you to dictate the level of heat the stove is pushing out.

TEMPERATURE CONTROL MODE

The Temperature Mode allows you to set the temperature of the room. The stove will increase or decrease the level of heat it puts out automatically to keep the room at the set temperature. To increase or decrease the "call to" temperature, use the SCROLL UP or SCROLL DOWN button. The current room temperature will be displayed at the location as 5 showed on Figure 19. And the "call to" temperature will be displayed at the location as 3 showed on Figure 2. If the room temperature falls below the "call to" temperature, the stove's heat power level indicator will automatically rise to five. When the temperature has been reached, the heat power level will return to one and it will stay there until more heat is needed.

Note: In Temp mode, the stove will not go in standby. It will simply idle and continue to produce a fire until the room is no longer at the set "call to" temperature. When it is idling, the stove will read at power level one in the power level box on the display screen.

WEEKLY MODE

The Weekly Mode allows an stove user to control and schedule the stove operation during set times and days throughout the week. You can select four different operation times for each of the seven days of the week.

Thermostat MODE

*Currently not used

PROPER DOOR CLOSING

In order to shut the door correctly, close the handle from the 1 o'clock position to the 5 o'clock position, turning clockwise

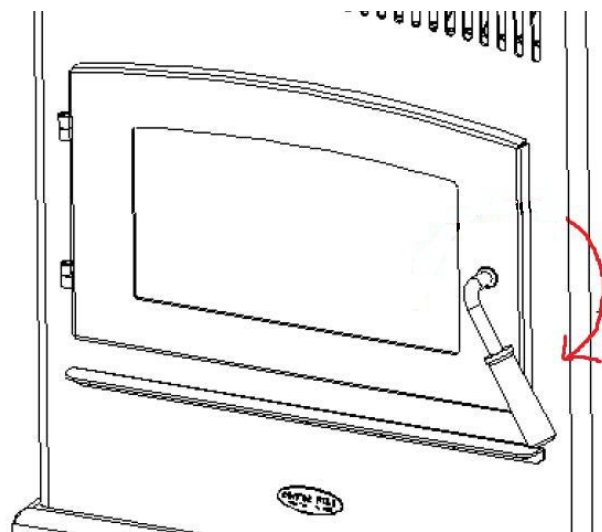

Figure 22

SETTING DATA ON YOUR CONTROLLER

Press and hold the ENTER button. This will take you to the

"Set Data" screen.(Figure 23)

Set Data	
→	1: General
	2: Set Weekly
	3: Set Combustion
	4: Set Ash Cleaning Cycle
	5: Set ECO
	6: Diagnosis
	7: Safe mode
	8: Information
	9: Set Blower
	10 Reset

Figure 23

SETTING General

Press ENTER again to enter the "General" screen.(Figure 24)

General	
→	1: Time: 00:00 Monday
	2: Temp Units: °C
	3: Language: ENGLISH

Figure 24

- 1) Press ENTER to highlight the hour. Use your SCROLL UP and SCROLL DOWN buttons to select the correct hour, and then press ENTER a second time to begin setting the minutes. And then press Enter to highlight the day of week and setting. To change the hour, press ENTER. This will highlight the hour. Use your SCROLL UP and SCROLLDOWN

buttons to choose the appropriate time. Press ENTER to select the correct hour, and then press ENTER a second time to begin setting the minutes.

Continue this process for selecting and setting the day of week.

2): SCROLL DOWN buttons to select the Temp units.

Press ENTER to highlight the UNITS and set. Press ENTER again to exit the highlight.

3): Choose the language you want.

SETTING THE WEEKLY

Select "Set Weekly." Press ENTER. This will take you into the Weekly Schedule screen. (Figure 25)

Weekly	→ MON	ALL
1:	--:-- ~ --:-- °C	NO
2:	--:-- ~ --:-- °C	NO
3:	--:-- ~ --:-- °C	NO
4:	--:-- ~ --:-- °C	NO

Figure 25

1. In the "Weekly Schedule" screen, you can begin with selecting the target day of the week. Press ENTER to highlight the MON and use the SCROLL UP and SCROLL DOWN buttons to reach the target day. Press ENTER to confirm.
2. Move to Select the first time-setting line, you can begin with setting the operation times for Monday. Press ENTER to highlight the hour and use the SCROLL UP and SCROLL DOWN buttons until you reach your desired hour of start time. Press ENTER again to highlight the minutes and use SCROLL UP and SCROLL DOWN until you've reached your desired minute of start.

NOTE: Your stove controller uses military time to set your weekly schedule.

3. Pressing ENTER again will allow you to set the stop time of your stove. Use the same procedure for setting your stove's start time for selecting when you would like the stove to stop. Once you've selected the stop time, press ENTER.
4. Next you will have the opportunity to set the desired temperature. Use the SCROLL UP or SCROLL DOWN keys until you've reached the appropriate temperature for the times you have selected. Press ENTER.
5. "Yes" will now be highlighted. If you have set this particular time correctly, press ENTER. This will take you out of your first set time.

HP55 Pellet Stove

If you wish to erase a scheduled time, use your ENTER key to highlight Yes on the screen for that scheduled time.

Select "No" using your SCROLL UP OR SCROLL DOWN key. With "No" highlighted, press ENTER to erase the data.

6. To set another time for that particular day, press SCROLL DOWN and continue by repeating steps 2-5 as appropriate.

NOTE: You must set your times in chronological order. The first schedule slot of one day MUST be earlier in the day than the second schedule slot on your weekly schedule list, etc.
7. Once you have set all times for Monday, SCROLL up to select "Monday" again and change to another day of week.
8. **After you have set a particular time for a day, if you wish to set that time for every day of the week, Press the SCROLL up and Scroll down key to select and highlight "All". Pressing ENTER will then select that scheduled time and apply it to each day of the week.**
9. Once you've finished setting your schedule, without any of the options highlighted, press the EXIT button. This will save your schedule.
10. With a schedule set, make sure that the main display screen on the controller reads "Weekly" (for operating in the Weekly Mode) and that the unit is turned on. The schedule will not take effect unless the unit is turned on in the Weekly Mode.

SETTING the combustion parameter

Select the "Set Combustion", and press enter. This will take you into the "Combustion" screen. (Figure 26)

Combustion	level:H01
1: Feed rate: on 19 off 41	
2: Exhaust Voltage:100V	
3: Blower Voltage: 120V	

Figure 26

- 1) Press to highlight the level and then change to the level need to set. Press again to exit highlight.

Note: The level item has 8 options :

IG01 ,IG02,IG03 : correspond to ignition stage.

H01,H02,H03,H04,H05:correspond to Heating stage.
- 2) Move to "Feed rate". Press ENTER to highlight the value of on . Use your scroll up and scroll down button to choose the appropriate value. Press Enter to exit highlight and then the value of off is highlight. Use your

scroll up and scroll down button to choose the appropriate value.

- 3) Move to "Exhaust Voltage", and press Enter to highlight the value behind the "Exhaust Voltage".

Use your scroll up and scroll down button to choose the appropriate value.

NOTE: The option is just for serviceman.

IMPORTANT NOTE: BEFORE INCREASING THE EXHAUST VOLTAGE, if you are having issues with getting enough air to your fire, FIRST try to adjust the air flow gate. SEE FIGURE 27. This will also adjust the air flow to the stove.

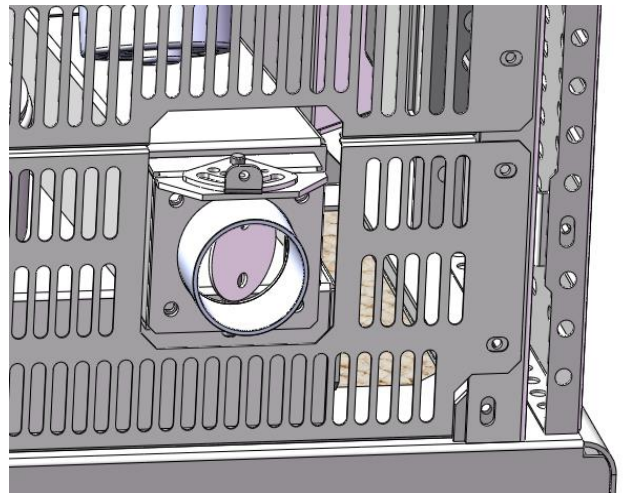

Figure 27

! WARNING

The adjustments will affect emissions. Pls contact the saler for advice before you want to change any setting.

The exhaust voltage (controlling the combustion motor) allows you to adjust the stove for the fuel you are burning or compensate for inadequate ventilation situations. In less than optimum venting situations, you can increase the exhaust speed for additional air circulation through the stove should ventilation be an issue.

IMPORTANT: Changing the exhaust voltage does NOT change the feed rate. Therefore, on high heat power levels where the feed rate is faster, a low voltage level will not push out enough air and the stove may overheat and pellets may back up into the pot. Decreasing exhaust voltage will increase the amount of heat coming into the room. Do not adjust the exhaust voltage too low, as it can cause pellets to backup in the burn pot.

Operator's Manual
HP55 Pellet Stove

Increasing the exhaust voltage, and thereby increasing the amount of air in the burn pot, will also assist in burning lower-quality fuels that may otherwise cause unwanted buildup.

NOTE: Be sure to visually watch the burn rate if the combustion voltage is decreased, as to not cause pot overloading. Exhaust voltage should ONLY be adjusted to get the optimum performance out of the fuel you are burning.

4) Move to "Blower voltage ", set the Correct value.

The blower voltage (controlling the room fan) can be turned up or down for each power level to regulate the amount of heat circulated into a room during stove operation. Some fuels radiate heat better than others. You have the ability to speed up or slow down the room fan to extract the optimum amount of heat without blowing cold air. Increasing the blower voltage causes the convection motor to run faster, extracting more heat from the unit.

NOTE: *If having issues with the stove overtemping in any setting, increase the blower voltage.*

Decreasing the blower voltage allows you to slow the exchange of heat from the stove so it blows less cold air

Set Ash Cleaning Cycle

Select the "Set Ash Cleaning Cycle", and press enter. This will take you into the "AshCleaning" screen. SEE FIGURE 28.

AshCleaning	level:H01
→ 1: Time span: -- Min	
2: Duration:--Sec	
Smart Ash Cleaning: ON	
Light ● Medium ○ Heavy	

Figure 28

Ash clean cycle include the Time Span (** Min) and Duration time(**Sec)

During The Duration time period ,the feed is stop and the exhaust fan funning at full speed. The period between two lasting time is the Span Time. It can be adjust from 30min to 60 min.

Smart Ash cleaning is an automatic Ash cleaning cycle. It has 3 setting: light ,medium ,heavy.

Set ECO

Select the "Eco", and press enter. This will take you into the "Eco" screen. SEE FIGURE 29.

If the ECO is on, the stove will shut down when the room temperature matches the call to temperature. Then when the thermostat calls for heating , the stove will start again.

If the ECO is off, the stove will keep idle (level 1) when the room temperature matches the call to temperature.

Set Eco
ECO:ON

Figure 29

DIAGNOSTICS

Your Stoves controller comes equipped with an on-board diagnostics option that will let you test some components of your stove.

NOTE: *You will only be able to enter the diagnostic screen when the stove is turned OFF.*

Select the "DIAGNOSTICS", and press enter. This will take you into the "Diagnostic" screen. (Figure 30)

Diagnostic	level:H01
Fire: ● Exhaust: ● Feed:●	
Blow:●Limit: ● Vacuum: ●	
POF: ●	
Hopper T: 50 °C	Room T:40 °C

Figure 30

level: Changing the level will allow you to test the component in the various heating power levels.

Fire :Indicates whether the igniter is working properly.

Exhaust: Indicates whether the combustion motor and exhaust system is working properly.

Blower: Indicates whether the room fan/blower is working properly.

Feeding: Indicates if the auger is properly feeding pellets.

Limit: Indicates the hopper lid is properly shut.

Vacuum: Indicates there is sufficient vacuum and suction.

POF : Indicates the proof of fire switch is properly working.

Hopper T :Indicates temperature being read by over

*The device bubbles will only be shaded when that device is in an engaged or activated state. When stove is off, only the bubble next to Limit may be shaded.

Operator’s Manual
HP55 Pellet Stove

temp sensor. (Temperature is in Celsius)
 Room T: Indicates temperature being read by room temp sensor.

In the diagnostic mode, you will have the ability to test certain components of your stove to see if they are properly working. By using the ENTER button, you can highlight “Fire,” “Exhaust,” “Blower,” or “Feeder”. When one of these options is highlighted, you can use the SCROLL UP or SCROLL DOWN buttons to unshade or shade in the circle next to the stove component it represents. This manually attempts to turn on these components to see if it works properly.

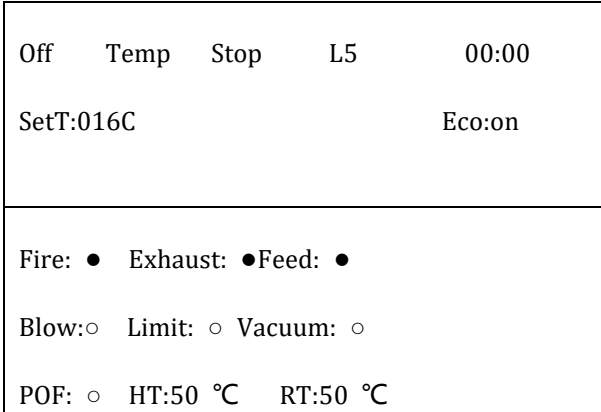

Figure 33

You can check if the status of the stove is right .

2) Stove Information

Select the “Stove Information”, and press enter. This will take you into the “Stove information” screen.(Figure 34)

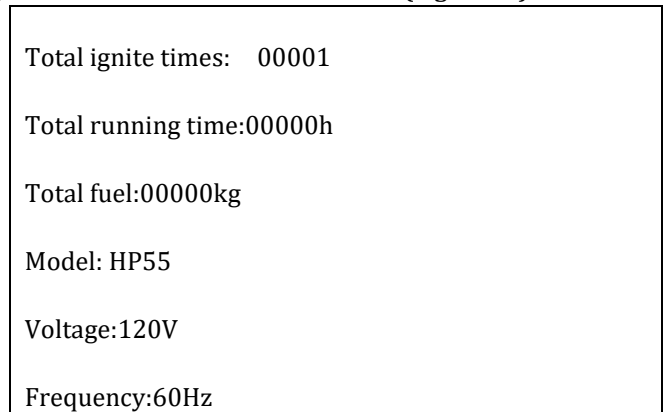

Figure 34

Total ignite times: count the times of ignite and add up
 Total Running time: the total working time of the stove
 Total fuel: The total fuel consumption.

Safe Mode

Select the “Safe Mode”, and press enter. This will take you into the “Safe Mode” screen. (Figure 31)

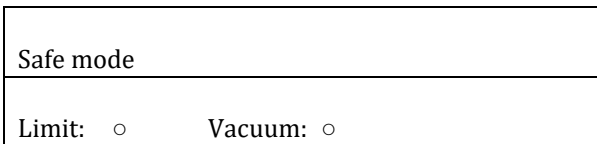

Figure 31

In the safe mode, you will have the ability to bypass these two components of your stove to see if they are properly working.

Note: The option is just for serviceman.

Information

Select the “Information”, and press enter. This will take you into the “information” screen. (Figure 32)

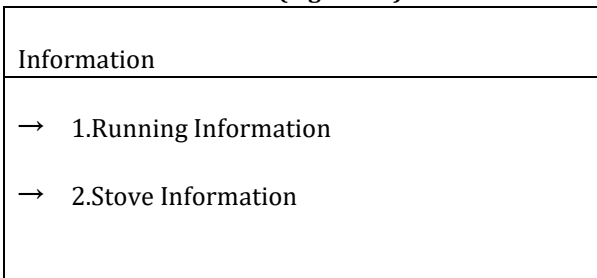

Figure 32

1) Running Information

Select the “Running Information”, and press enter. This will take you into the “Running information” screen. (Figure 33)

Operator's Manual
HP55 Pellet Stove
SET Blower

Select the "set Blower", and press enter. This will take you into the "Set Blower" screen. **SEE FIGURE 36.**



Figure 36

You can set Blower off only when the pellet stove have dual convection constructions: natural convection and Blower convection.

RESET

Select the "Reset", and press enter. This will take you into the "Reset" screen. **SEE FIGURE 37.**

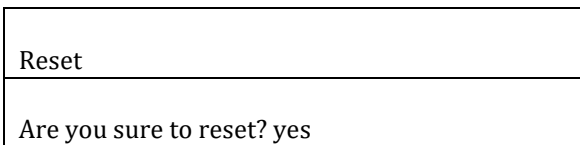



Figure 37

If at any time you desire to return your controlled stove settings to their original state, (i.e. rest blower voltage levels or weekly schedules) your stove does have the ability to restore the default settings.

SHUT DOWN PROCEDURE

Press the  button on the control pad to initiate the shut down mode. The On/Off indicator on the screen will read OFF. The auger will stop feeding pellets, but the room air distribution blower and exhaust fan will continue to operate. Once the stove has cooled down, the screen light will turn off.



WARNING

NEVER SHUT THE STOVE DOWN BY UNPLUGGING IT FROM THE POWER SOURCE.

NEVER SHUT THE STOVE DOWN BY SWITCHING OFF THE MAIN POWER SWITCH ON THE REAR OF THE STOVE.

Display at the stove	Action to be taken
Lost connect	Check if the plug of data cable is loose
Ignite failure	1.Check if Pellet fall into burnpot 2.check if ignitor work properly 3.check if exhaust fan stop or door is not close
Low Temperature	Check if Hopper is empty
High Temperature	Check if feeding is abnormal

Figure 38

Alarm Messages

All alarm messages are showed as below. (figure 38).

MAINTENANCE

NORMAL CARE AND MAINTENANCE

Due to differences in fuel, stove cleaning intervals will vary. The cleaner the stove is, the more efficiently it will burn.

CLEANING THE FIREPOT

Remove and clean the burnpot/firepot daily. Make sure all holes in the burn pot are unobstructed. Use a small metal pick or drill bit to keep these holes clean. **SEE FIGURE 46**

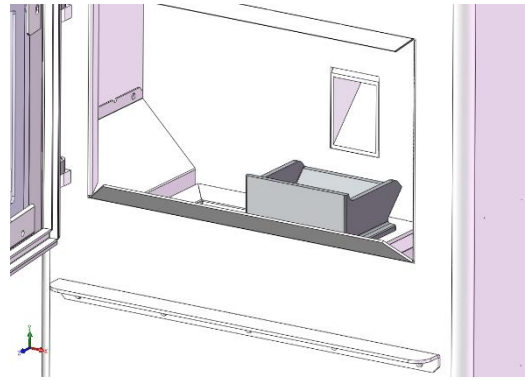

FIGURE 46

FIREPOT REMAINS

Every time the hopper is filled with fuel, the firepot should be emptied. To empty the firepot, lift it out of the pot holder and dump it directly into the ash pan. Be sure any build-up is removed and that the holes are clean.

CLEANING THE GLASS

Only clean the glass when the glass is cool. Wipe glass off frequently. Wipe the glass clean with a dry or damp rag. If this does not clean the glass, use any non-abrasive cleaner. Using ceramic stove top cleaner can be helpful in removing soot from the glass. Inspect gaskets around the door periodically. Replace any worn, frayed or compacted gaskets. Replace broken glass only with high temperature ceramic glass. **SEE FIGURE 47**

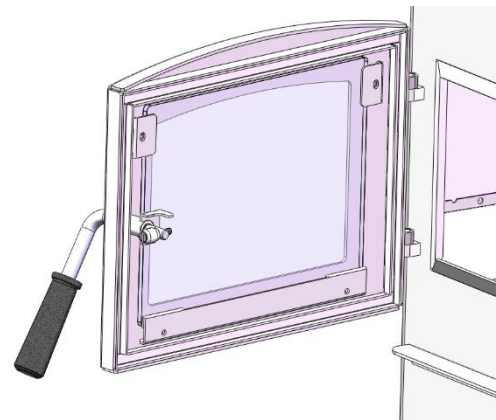

FIGURE 47

INTERIOR CHAMBER

Clean the interior chamber with an ash vacuum. Ash vacuums are specially designed to contain soot and have a metal exterior.

ASH PAN

Dump the ash pan regularly. Ashes should be contained in a metal container with a tight fitting lid. The closed container of ashes should be placed on a non combustible floor or on the ground, well away from all combustible materials. If ashes are disposed of by burial or otherwise locally dispersed, they should be retained in the closed container until all cinders have been cooled. **SEE FIGURE 48**

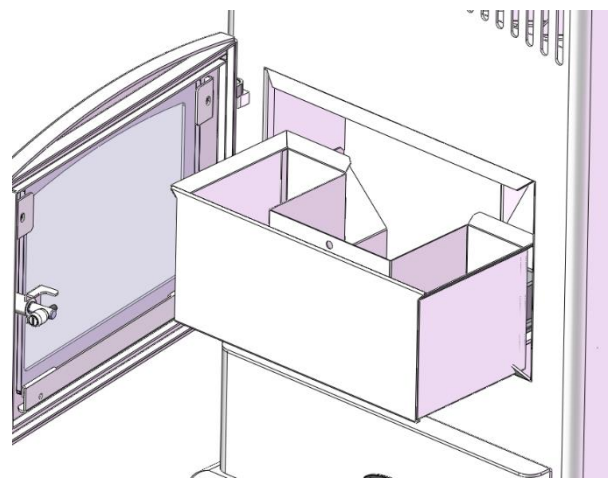

FIGURE 48

SOOT AND FLY ASH

The products of combustion will contain small particles of fly ash. The fly ash will collect in the exhaust venting system and restrict the flow of the flue gases. Incomplete combustion, such as occurs during startup, shutdown, or incorrect operation of the room heater will lead to some soot formation which will collect in the exhaust venting system. The exhaust venting system should be inspected at least once per month to determine if cleaning is necessary. If cleaning is necessary, disassemble the exhaust vent and clean the individual parts. When cleaning ash, use an approved ash vacuum. See a dealer for more details.

Check clean out tees regularly to determine the required cleaning interval. Use a 3" or 4" chimney cleaning brush to clean the exhaust venting. Plugged venting will effect the quality of the fire. Make sure to clean any screens in the venting regularly. A plugged screen will shut of combustion air and cause the fire to die or burn poorly.

DAILY MAINTENANCE

The surfaces of the stove may be hot. Always wear a protective glove, even when the stove is cool to the touch.

Empty firepot of ashes. Lift the firepot from the holder and dump it directly into the ash pan. **SEE FIGURE 49**

Remove any build-ups and be sure all of the holes are clean. Dump the ash pan into a metal container with a tightly fitting lid. The closed-container of ashes should be placed on a non-combustible floor or on the ground, well away from all combustible materials, pending final disposal. The ash dumping will be determined by the amount of fuel burned. It may need to be done up to three times a week. **SEE FIGURE 50**

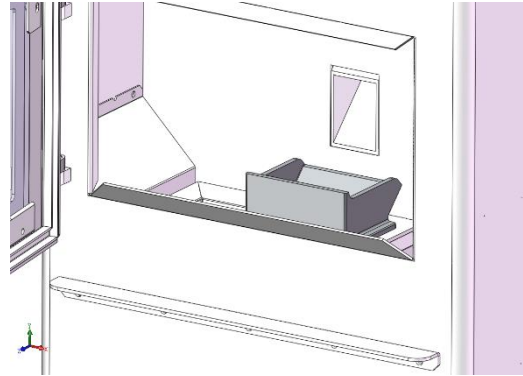

FIGURE 49

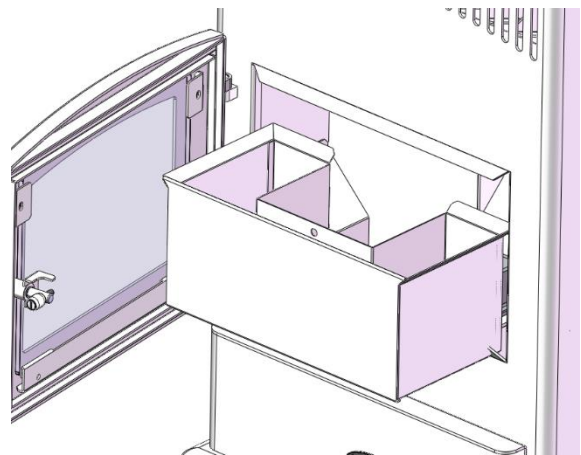



FIGURE 50

	<h2>WARNING</h2> <p>NEVER PERFORM CLEANING OR MAINTENANCE ON A HOT STOVE. ALLOW UNIT TO COOL FOR A MINIMUM OF TWO HOURS. NEVER PERFORM SERVICE WITH POWER SUPPLIED TO THE UNIT</p>
---	---

WEEKLY MAINTENANCE

In addition to daily maintenance tasks, use an ash vacuum to clean the inside of the firebox.
Remove the firepot from the pot holder and vacuum beneath.
Be sure to remove any ash from the incoming ignitor tube.
SEE FIGURE 51

MONTHLY MAINTENANCE

In addition to daily and weekly maintenance tasks, the lower exhaust housing cover plate should be removed and vacuumed thoroughly. **SEE FIGURE 52**
This may require a hose adapter to reach inside the exhaust housing. This should be done monthly, or with every 2-3 tons of fuel burned.

IMPORTANT NOTE: A HOLE CAN BE CUT IN THE GASKET USING A UTILITY KNIFE TO ACCESS THE housing. THIS WILL ALLOW YOU TO REUSE THE GASKET

Annually (OR EVERY 3-4 TONS OF FUEL)

Remove and clean the exhaust venting.
Remove and clean the combustion motor, housing and impellers. **SEE FIGURE 53**

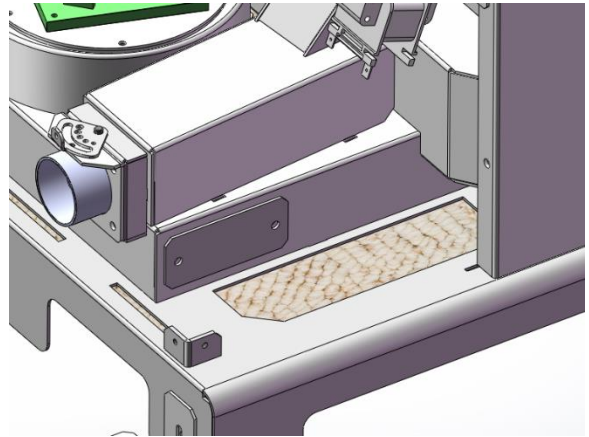

Figure 52: Remove exhaust housing cover plate and clean

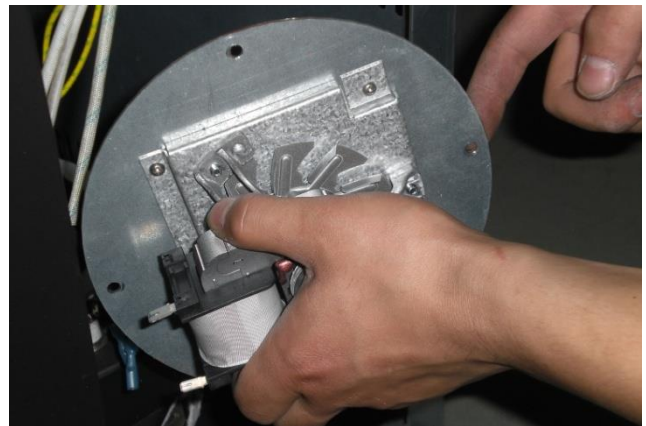

Figure 53: Remove combustion motor and clean

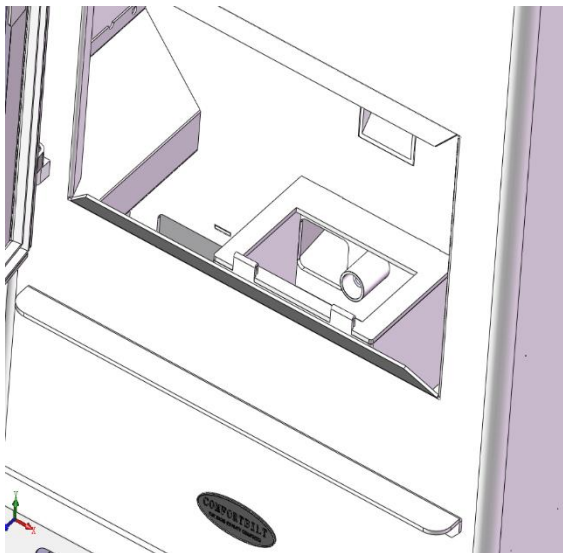



FIGURE 51

Note: There is a Combustion Motor Gasket, which allows you to remove the motor from the Combustion Blower housing, clean your stove, and replace the motor and gasket without having to remove the entire Combustion Blower. However, if you must remove or replace the entire Combustion Blower, a new blower flange gasket should be added between the blower flange and the steel exhaust tube.

TROUBLESHOOTING & REPAIR

We build quality and durability into the design of our products; but no amount of careful design by us, and careful maintenance by you, can guarantee a repair-free life for your stove. Most repairs will be minor, and easily fixed by following the suggestions in the troubleshooting guide in this section. The guide will help you pinpoint the causes of common problems and identify remedies. For more complicated repairs, you may want to rely on your retailer. A parts catalog is included in this section. We will always be glad to answer any questions you have, or help you find suitable assistance.

 **WARNING**

WHEN PERFORMING ANY INTERNAL MAINTENANCE.

- **MOVING PARTS INSIDE OF THE CABINET MAY CAUSE INJURY. DO NOT OPERATE UNIT WITH PANELS REMOVED OR OPEN.**
- **HOT PARTS. DO NOT OPERATE THE UNIT WITH PANEL OPEN.**
- **RISK OF ELECTRIC SHOCK. DISCONNECT POWER BEFORE SERVICING UNIT.**
- **IN THE EVENT OF COMPONENT FAILURE, REPLACE WITH THE ORIGINAL FACTORY EQUIPMENT**

 **CAUTION**

THIS IS A MINIMUM REQUIREMENT FOR SOOT AND FLY ASH REMOVAL. ASHES SHOULD BE PLACED IN A METAL CONTAINER WITH A TIGHT FITTING LID. THE CONTAINER SHOULD BE PLACED ON A NON-COMBUSTIBLE FLOOR, WELL AWAY FROM COMBUSTIBLE MATERIALS, PENDING FINAL DISPOSAL. IF ASHES ARE DISPOSED OF BY BURIAL IN SOIL OR OTHERWISE LOCALLY DISPERSED, THEY SHOULD BE RETAINED IN THE CLOSED CONTAINER UNTIL ALL CINDERS ARE NO THOROUGHLY COOL

 **CAUTION**

DO NOT OPERATE STOVE WITH BROKEN GLASS.

DO NOT SLAM THE DOOR SHUT.

DO NOT STRIKE GLASS.

DO NOT USE ABRASIVE CLEANERS.

DO NOT CLEAN HOT GLASS.

REPLACE CERAMIC GLASS WITH FACTORY AUTHORIZED REPLACEMENT PARTS ONLY.

THE CLINKER WILL REMAIN HOT FOR SEVERAL MINUTES AFTER IT IS PULLED OUT OF THE FIRE POT

TROUBLESHOOTING GUIDE

Unplug stove before performing any maintenance.
**NEVER TEST OR CHECK ELECTRICAL COMPONENTS
 UNLESS STOVE IS UNPLUGGED FROM POWER SUPPLY**



WARNING

NEVER SERVICE OR TOUCH THE FEED AUGER WITH THE STOVE PLUGGED IN.
NEGATIVE PRESSURE IN A HOME IS A SERIOUS ISSUE. IF THERE IS A PROBLEM, THE STOVE SHOULD BE INSTALLED WITH A FRESH AIR KIT (NOT INCLUDED).

PROBLEM	CAUSE	SOLUTION
Fault light comes on	Fire goes out	Control reads out of fuel, check burn pot. Add fuel to the hopper. If the hopper is full, relight if it continues to give that signal. Then enter the diagnostic area of the controller. A circle next to "NTC1" should be highlighted. If not, replace the 52C proof of fire switch.
PROBLEM	CAUSE	SOLUTION
Fault light is on	Overtemp	Enter the diagnostic area of the controller. There should be a number reading in Celsius next to NTC2. The room fan can be tested by highlighted the circle next to "Blower". Allow stove to cool and restart. Check exhaust pipe for obstructions.
PROBLEM	CAUSE	SOLUTION
Fuel not feeding, no vacuum signal on the control	Main door or ash pan not sealed. No negative pressure in fire chamber Piping or stove may be plugged with ash	The pressure sensor shuts off the feed auger when there is no negative pressure in fire chamber. Check door seals. Clean venting and stove through cover plate clean-out hole. Enter the diagnostic area on the controller and highlight the circle next to feeding; this should cycle the auger and feed pellets. The exhaust motor should turn on and within 20 seconds, the vacuum signal should also become high-lighted.
PROBLEM	CAUSE	SOLUTION
Fuel not feeding, vacuum and hopper lid signal present on the control	Auger is obstructed Auger not working	Remove auger from housing and clean obstruction first. Enter the diagnostic area in the controller and highlight the circle next to "feeding". This should cycle the auger and feed pellets. Replace auger if necessary

Operator's Manual
HP55 Pellet Stove

PROBLEM	CAUSE	SOLUTION
Fuel not feeding, no hopper lid signal on control	Hopper lid is open Hopper lid switch not functioning correctly	Close hopper door. Enter the diagnostic area on the controller; circle next to "limit" should be highlighted when the hopper lid is closed. The circle will be unshaded if the hopper lid is opened. Check hopper door seal. Replace hopper safety switch if not operating properly.
PROBLEM	CAUSE	SOLUTION
Fire burns lazy and smoky	Stove is dirty Poor quality fuel	Clean fire pot. Clean ash pan. Clean exhaust vent system. Clean stove through cover plate clean-out hole. Increase exhaust motor Voltage.
PROBLEM	CAUSE	SOLUTION
Feeds fuel will not light all; control indicators are on	Igniter tube or burn pot plugged with ash Faulty igniter	Clean fire pot, clean igniter tube. Enter the diagnostic area in the controller and test the ignitor by highlighting "fire". You should feel heat coming from the igniter holder within two minutes. Replace if necessary

WARRANTY

This warranty is non-transferable and is made to the original retail purchaser only provided that the purchase was made through an authorized dealer of SMG. It must be installed and operated at all times in accordance with the Installation and Operating Instructions furnished with this product, as well as any applicable local and national codes. Any alteration, willful abuse, accident, or misuse of the product shall nullify this warranty.

SMG Hearth and Home LLC, a Manufacturing Company warrants this HP55 Stove to be free from defects in the material or workmanship for a period of one year. During that one-year period, SMG will, at their discretion, furnish parts and labor to correct any defect caused by faulty material or workmanship. For other warranty repairs, please read the one-year warranty listed below.

ONE-YEAR WARRANTY

All electrical components such as but not limited to blowers, wiring, vacuum switches, speed controls, control boxes, switches, pilot assemblies, thermostats, and igniters are covered under SMG Hearth and Home LLC's one-year warranty. Our firepots and labor are also covered under the one year warranty.

THIS WARRANTY IS LIMITED TO DEFECTIVE PARTS-REPAIR AND/OR REPLACEMENT AT SMG Hearth and Home LLC'S OPTION AND EXCLUDES ANY INCIDENTAL AND CONSEQUENTIAL DAMAGES CONNECTED THEREWITH.

This warranty is not transferable and supersedes all other warranties either expressed or implied and all other obligations to liabilities on our part. SMG Hearth and Home LLC. does not assume, and does not authorize any other person to assume for us, any liability in connection with the sale of our products. The warranty applies only to products which have not been subjected to negligent use, misuse, alteration, accident or repairs made by anyone not certified by SMG Hearth and Home LLC.



www.comfortbilt.net

SMG Hearth and Home LLC

9241 Globe Center Drive Suite 120

Morrisville, NC 27560

919-973-4092

919-973-4123

Technical service calls are answered Monday thru Friday
9am to 5pm eastern time.